

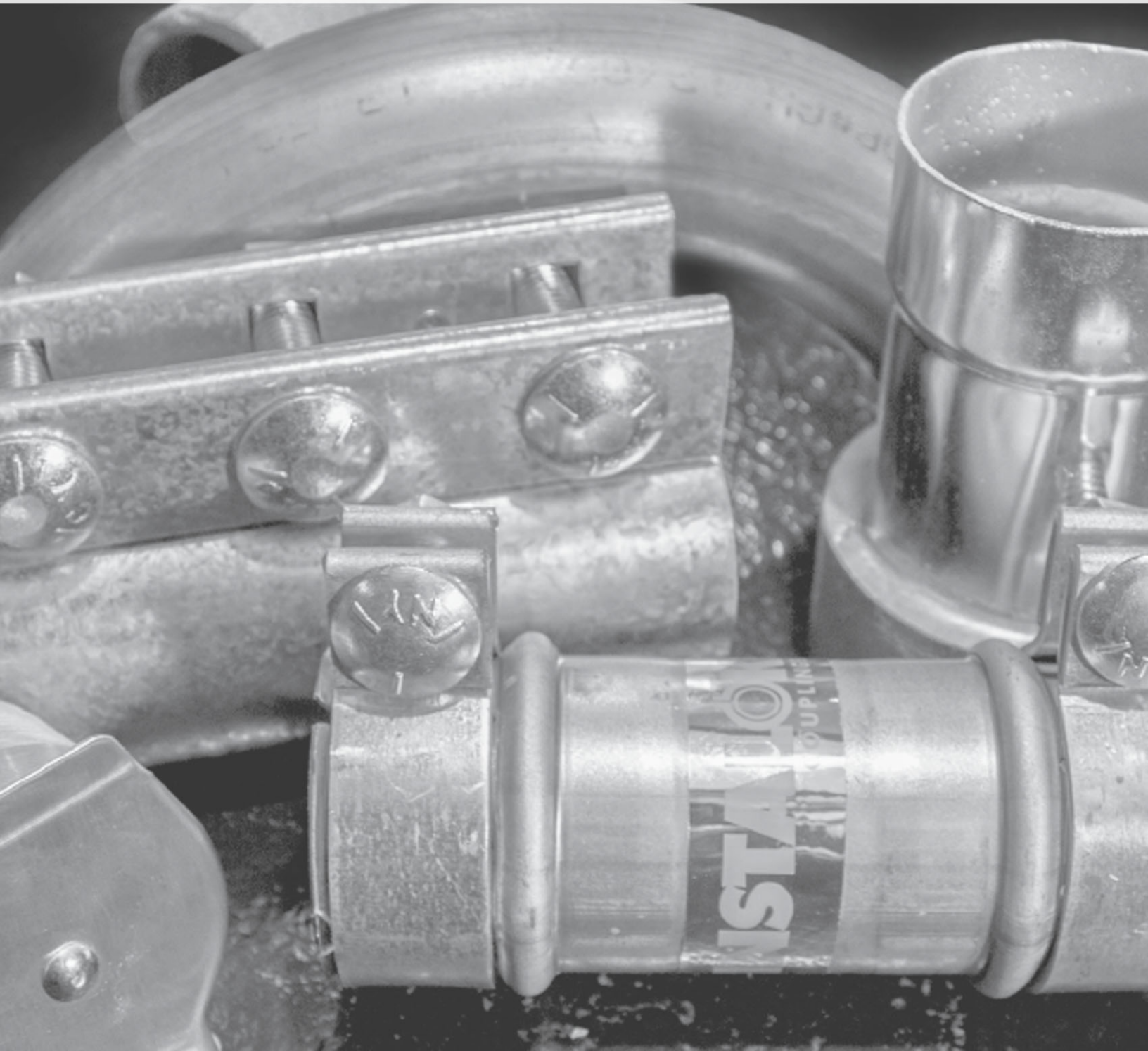

# **Legends Equipment LLC**

TUBING, BENDS, COUPLINGS AND FITTINGS



# ASSEMBLY OPTIONS



Shrink Sleeve with  
expanded end fittings

*(Carbon Steel Shown)*



Instalock coupling

*(Zinc Galvanized Shown)*



Compression coupling

*(304 Stainless Steel Shown)*



Proper tubing and fittings are critical to a working central vacuum system.

Select your materials of construction:

- Carbon Steel
- Zinc Galvanized (standard)
- 304 Stainless Steel

Select your style of coupling:

- Shrink Sleeve
- Instalock (standard)
- Compression Coupling

Our engineers will design the tubing network based on your plant layout and provide dimensional drawings and installation guidelines for installation.

Proper sizing of the tubing is critical for a system that will not plug.

# SERVICES

## TABLE OF CONTENTS

SERVICES..... 2-3

### STANDARD ELBOWS & BENDS

Bending Capabilities..... 4

Standard Tubing.....5

Valves..... 6

Standard Radius Elbows..... 7

Short Radius Elbows.....7

Standard Long Radius Bends .. 8

### FITTINGS

Standard 90° TY's .....9-10

Standard 45° YL's..... 11-12

Standard Double Y's.....13

Standard Reducing Couplings 14

Standard Adapters..... 15-17

### METHODS OF JOINING

Slip Couplings..... 18

Shrink Sleeves ..... 18

Wrapped Sleeves ..... 18

Instalok™ Couplings ..... 19-20

Compression Couplings... 21-22

Slip Welding Rings..... 23

Tube Hangers, Plugs, Nipples 23

### ACCESSORIES

Accessories ..... 24-26

## WHEN ORDERING, PLEASE SPECIFY TYPE OF MATERIAL

- Carbon
- Stainless
- Aluminum
- Galvanized Steel

## TUBING

*Our standard catalog items include tube sizes from 2-1/8" through 14" OD in Carbon, Stainless, Aluminum and Galvanized Steel. 1-1/2" and 2" OD are available upon request.*

### TUBE DIMENSIONS

16 Gauge = .065"  
14 Gauge = .083"  
12 Gauge = .109"  
11 Gauge = .120"

## DELIVERY

*Fast delivery is available on a wide selection of in-stock Tubing, Bends, Couplings, Fittings and Installation Components. We'll also make every effort to meet emergency requirements for non-stock items.*

## NOTE

*Specifications subject to change without notice, without incurring any obligation on our part.*

# STANDARD ELBOWS & BENDS

All reference dimensions are nominal

## STANDARD SPECIFICATIONS

- Inventories include a wide range of parts:
  - Standard Elbows (2-1/2" times OD)
  - Short Radius Elbows (1-1/2" times OD)
  - Long Radius Bends (over 2-1/2" times OD)
- Smooth, wrinkle free elbows
- Standard Gauges (2-1/8" to 4" OD = 16 Gauge)  
(5" to 8" OD = 14 Gauge) (10" to 14" OD = 12 Gauge)
- 11 Gauge Available upon request with Straight Ends Only
- Materials: Carbon, Stainless, Aluminum, Galvanized Steel

## TUBE BENDING CAPABILITIES

OD (IN.)	CENTER LINE RADIUS (IN.)	GAUGE
1-1/2	1-3/4, 2-1/2, 3, 4, 6, 7-1/2, 9, 12, 15, 18, 24, 30, 36	11, 14, 16
1-3/4	2-1/2, 3, 4, 4-1/2, 6, 8, 9, 12, 15, 24, 30, 36	11, 14, 16
2	2, 2-1/2, 3, 3-1/2, 4, 5, 6, 8, 9, 10, 12, 15, 18, 24, 30, 36, 48	11, 14, 16,
2-1/8	2-7/8, 3-1/2, 5, 12, 20, 24, 36	11, 16
2-1/4	2-1/2, 3, 4, 5-1/2, 8, 9, 12, 15, 18, 24, 30, 36, 42	11, 14, 16
2-3/8	2-3/8, 3, 6, 8, 12, 18, 24, 30, 36, 48	16
2-1/2	2-1/2, 3, 3-1/4, 3-3/4, 4, 5, 6, 9, 12, 15, 18, 24, 30, 36, 48	11, 14, 16
2-3/4	2-3/4, 3-7/8, 15, 24, 30	11, 14, 16
2-7/8	3-3/4, 9, 10, 12, 24, 30, 36, 48, 60	11, 14, 16
3	3, 4, 4-1/2, 6, 7-1/2, 9, 12, 15, 18, 24, 30, 36, 38, 48, 60	11, 14, 16
3-1/2	3-1/2, 4, 4-1/2, 5, 6, 7-1/2, 8, 8-3/4, 12, 13, 15, 18, 24, 30, 36, 48, 60	11, 14, 15, 16
4	4, 6, 8, 9, 10, 12, 18, 24, 30, 36, 48, 60	11, 14, 16
4-1/2	6, 9, 12, 16, 20, 24, 30, 36, 48, 60	11, 14, 16
5	5, 5-1/2, 7-1/2, 12-1/2, 18, 24, 30, 36, 48, 60	11, 14, 16
6	7, 9, 15, 24, 30, 36, 48, 60	11, 14, 16
8	12, 20, 32, 48	11, 14
10	20, 32, 48	11, 12

WHEN ORDERING,  
PLEASE SPECIFY  
TYPE OF MATERIAL

- Carbon
- Stainless
- Aluminum
- Galvanized Steel

### KEY

OD..... Outside Diameter  
NPS..... Nominal Pipe Size

## PIPE BENDING CAPABILITIES

NPS (INCHES)	OD (INCHES)	CENTER LINE RADIUS (INCHES)	SCHEDULE (INCHES)				
			5	10	40	80	OTHER
1-1/2	1.900	6, 9, 12, 18, 36	-	-	.145	.200	-
2	2.375	2-3/8, 3, 6, 8, 12, 18, 24, 30, 36, 48	.065	.109	.154	.218	-
2-1/2	2.875	3-3/4, 9, 10, 12, 24, 30, 36, 48, 60	.083	.120	.203	.276	-
3	3.500	4, 4-1/2, 5, 6, 7-1/2, 8, 8-3/4, 12, 13, 15, 18, 24, 30, 36, 48, 60	.083	.120	.216	.300	.188
3-1/2	4.000	4, 6, 8, 9, 10, 12, 18, 24, 30, 36, 48, 60	.083	.120	-	.300	-
4	4.500	6, 9, 12, 16, 20, 24, 30, 36, 48, 60	.083	.120	.237	.337	.188
5	5.563	24, 30, 36, 48, 60	-	.134	.258	.375	-
6	6.625	24	-	.134	.280	-	.188, .250
8	8.625	32	-	.148	.322	-	.188, .250

## STANDARD TUBING

We are capable of providing 1-1/2" - 14" OD

- 2-1/8" through 14" OD
- Wall Thickness: 16, 14, 12, 11 Gauge
- Materials: Carbon, Stainless, Aluminum, Galvanized Steel

OD	GAUGE	NOMINAL WALL THICKNESS	CARBON	GALVANIZED STEEL	STAINLESS	ALUMINUM
2-1/8"	16	0.065"	16WT212C	16WT212Z	16WT212S	16ST212A
2-1/8"	11	0.120"	11WT212C	11WT212Z*	11WT212S	11ST212A
2-1/2"	16	0.065"	16WT250C	16WT250Z	16WT250S	16ST250A
2-1/2"	11	0.120"	11WT250C	11WT250Z*	11WT250S	11ST250A
3"	16	0.065"	16WT300C	16WT300Z	16WT300S	16ST300A
3"	11	0.120"	11WT300C	11WT300Z	11WT300S	11ST300A
3-1/2"	16	0.065"	16WT350C	16WT350Z	16WT350S	16ST350A
3-1/2"	11	0.120"	11WT350C	11WT350Z*	10WP300S	11ST350A
4"	16	0.065"	16WT400C	16WT400Z	16WT400S	16ST400A
4"	11	0.120"	11WT400C	11WT400Z	10WP350S	11ST400A
5"	14	0.083"	14WT500C	14WT500Z	14WT500S	14ST500A
5"	11	0.120"	11WT500C	11WT500Z	11WT500S	11ST500A
6"	14	0.083"	14WT600C	14WT600Z	14WT600S	14ST600A
6"	11	0.120"	11WT600C	11WT600Z	11WT600S	11ST600A
8"	14	0.083"	14WT800C	14WT800Z	14WT800S	14ST800A
8"	11	0.120"	11WT800C	11WT800Z	11WT800S	11ST800A
10"	12	0.109"	12WT1000C	12WT1000Z	12WT1000S	12ST1000A
12"	12	0.109"	12WT1200C	12WT1200Z	12WT1200S	12ST1200A
14"	12	0.109"	12WT1400C	12WT1400Z	**	**

Our standard stock (unless noted) is 20', but we will cut to your specifications  
 \* 10' Lengths  
 \*\* Quotation Basis

**WHEN ORDERING,  
PLEASE SPECIFY  
TYPE OF MATERIAL**

- Carbon
- Stainless
- Aluminum
- Galvanized Steel

### KEY

OD.....Outside Diameter  
 GALV..Galvanized

# VALVES

All reference dimensions are nominal

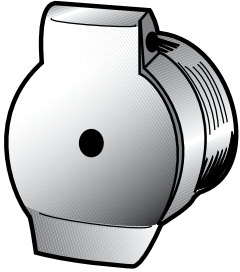

**Inlet Valve**

(For use with open tubing or when a flush mounting is not required)

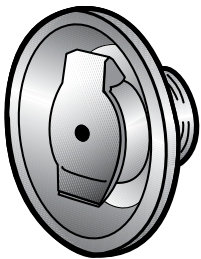

**Inlet Valve with Escutcheon**

(For a flush mounted installation)

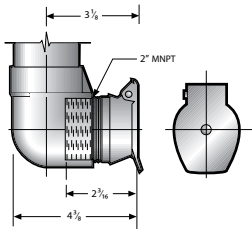

Valve shown in 90° adapter elbow (Part No. AE-211)

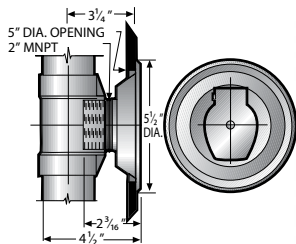

Valve with escutcheon and tee fitting. Can also be used with 90° adapter elbow

## KEY

FNPT = Female National Pipe Thread  
 MNPT = Male National Pipe Thread

## INLET VALVES

Heavy duty inlet valves provide for a quick connection of the male hose coupling to the vacuum cleaning system. These parts are designed for insertion into a 2" FNPT threaded fitting adapting to a 2-1/8" tube size. Valves have self-closing covers and are available in galvanized and stainless steel, as well as nickel plated models. Escutcheon plates allow for a more attractive wall installation.

The same body is used for all three valves...only the bore varies. IV-150 and IV-200 use a slight taper for hose adapter retention. IV-200-CLIP and IV-180 utilize a clip on the valve lid for retention instead. Hose adapters are constructed of heavy-duty galvanized steel.

## INLET VALVES

BORE	MNPT	PART #
1.5"	2.0"	IV-150
1.8"	2.0"	IV-180
2.0"	2.0"	IV-200
2.0"	2.0"	IV-200-CLIP

## ESCUTCHEON PLATES

TYPE	PART #
Zinc	10253
Stainless	23939
Nickel	25079

## INLET VALVE ACCESSORIES FOR INSTALLATION & OPERATION

HOSE ADAPTER PART #	HOSE SIZE	INLET VALVE PART#	WRENCH PART #
HA-150	1-1/2" ID	IV-150	VW-150
HA-180	1-1/2" ID	IV-180	VW-180
HA-200	2" ID	IV-200	VW-180
HA-200-RING	2" ID	IV-200-CLIP	VW-180

## PREMIUM INLET VALVES

Inlet valves are also available in stainless steel, nickel plated, and with an electric micro switch.

Call us for details.

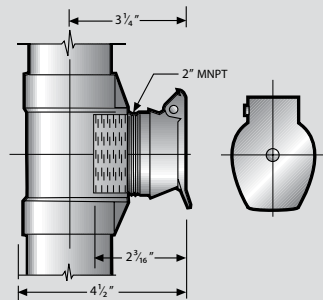

Valve shown in tube fitting (Part No. AT-212)

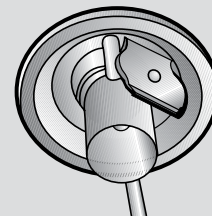

Inlet Valve with escutcheon being tightened into place with installation wrench

FNPT = Female National Pipe Thread

# STANDARD ELBOWS & BENDS

## STANDARD RADIUS ELBOWS

- 30° AND 60° ELBOWS AVAILABLE
- 11 GAUGE ELBOWS AVAILABLE (STRAIGHT ENDS ONLY)
- EXPANDED ENDS STANDARD THROUGH 6" SIZE
- EXPANDED ONE END AVAILABLE
- STRAIGHT ENDS AVAILABLE ON ALL SIZES BY REQUEST

A (OD)	B (CLR)	GAUGE	TAN.	C	90° PART NO.	C	45° PART NO.
2"	5"	16	2"	7"	EL-202	4-1/16"	EL-201
2-1/8"	5"	16	2"	7"	EL-212	4-1/16"	EL-211
2-1/2"	6"	16	2"	8"	EL-252	4-1/2"	EL-251
3"	7-1/2"	16	2"	9-1/2"	EL-302	5-1/8"	EL-301
3-1/2"	8-3/4"	16	2"	10-3/4"	EL-352	5-5/8"	EL-351
4"	10"	16	2"	12"	EL-402	6-1/8"	EL-401
5"	12-1/2"	14	2-5/8"	15-1/8"	EL-502	7-13/16"	EL-501
6"	15"	14	3-1/4"	18-1/4"	EL-602	9-7/16"	EL-601
8"	20"	14	4-1/4"	24-1/4"	EL-802	12-9/16"	EL-801
10"	32"	12	15"	47"	EL-1002*	28-1/4"	EL-1001*
12"	36"	12	6-1/4"	42-1/4"	EL-1202**	21-5/32"	EL-1201**
14"	36"	12	7-1/4"	43-1/4"	EL-1402**	22-5/32"	EL-1401**

- Expansion depth for standard and short radius elbows 1-3/8" through 4" OD and 1-5/8" for 5" and 6" OD
- Stainless parts (10" OR LARGER OD) are segmented
- \* Stainless parts are segmented
- \*\* Segmented

## SHORT RADIUS ELBOWS

- 30° AND 60° ELBOWS AVAILABLE
- 11 GAUGE ELBOWS AVAILABLE (STRAIGHT ENDS ONLY)
- EXPANDED ENDS STANDARD THROUGH 6" SIZE
- EXPANDED ONE END AVAILABLE
- STRAIGHT ENDS AVAILABLE ON ALL SIZES BY REQUEST

A (OD)	B (CLR)	GAUGE	TAN.	C	90° PART NO.	C	45° PART NO.
2"	3"	16	2"	5"	SR-242	3-1/4"	SR-241
2-1/8"	3-1/2"	16	2"	5-1/2"	SR-212	3-7/16"	SR-211
2-1/2"	4"	16	2"	6"	SR-252	3-21/32"	SR-251
3"	4-1/2"	16	2"	6-1/2"	SR-342	3-7/8"	SR-341
3-1/2"	5"	16	2"	7"	SR-352	4-1/16"	SR-351
4"	6"	16	2"	8"	SR-442	4-1/2"	SR-441
5"	7-1/2"	14	2-5/8"	10-1/8"	SR-542	5-23/32"	SR-541
6"	9"	14	3-1/4"	12-1/4"	SR-642	6-31/32"	SR-641
8"	12"	14	4-1/4"	16-1/4"	SR-842	9-7/32"	SR-841
10"	15"	12	5-1/4"	20-1/4"	SR-1042**	13-17/32"	SR-1041**
12"	18"	12	6-1/4"	24-1/4"	SR-1242**	16-3/16"	SR-1241**

- Expansion depth for standard and short radius elbows: 1-3/8" through 4" OD and 1-5/8" for 5" and 6" OD
- \*\* Segmented

### KEY

OD = Outside Diameter  
 CLR = Center Line Radius  
 TAN = Tangent Length  
 D = Expansion Depth 1-3/8" through 4" OD, 1-5/8" for 5" and 6" OD  
 E = Inside Diameter (ID) = A Outside Diameter (OD)

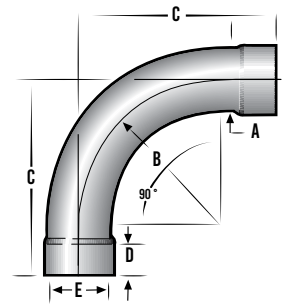

90° STANDARD RADIUS ELBOW

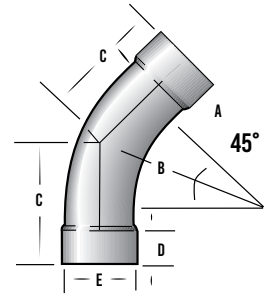

45° STANDARD RADIUS ELBOW

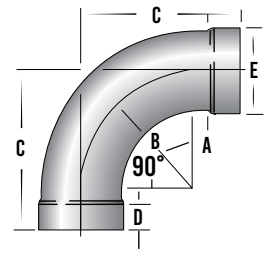

90° SHORT RADIUS ELBOW

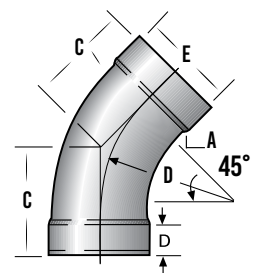

45° SHORT RADIUS ELBOW

### WHEN ORDERING, PLEASE SPECIFY TYPE OF MATERIAL

- Carbon
- Stainless
- Aluminum
- Galvanized Steel

# STANDARD ELBOWS & BENDS

All reference dimensions are nominal

## KEY

OD = Outside Diameter  
 CLR = Center Line Radius  
 C = Center to end  
 All reference dimensions are nominal

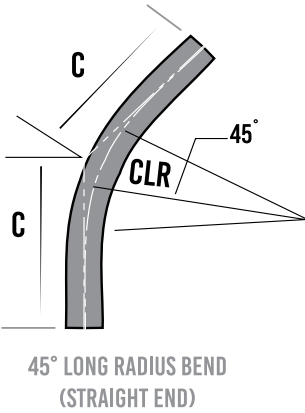
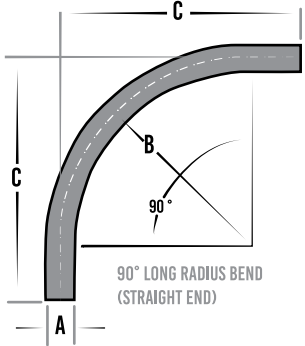

## STANDARD LONG RADIUS BENDS

• EXPANDED ENDS AVAILABLE UPON REQUEST, EXCEPT ON 8" AND 10" BENDS & ALL 11 GAUGE BENDS

A (OD)	B (CLR)	GAUGE	C	90° PART NO.	C	45° PART NO.
2-1/8"	24"	16	30"	16-212242	15-15/16"	16-212241
2-1/8"	24"	11	30"	11-212242	15-15/16"	11-212241
2-1/8"	36"	16	42"	16-212362	20-15/16"	16-212361
2-1/8"	36"	11	42"	11-212362	20-15/16"	11-212361
2-1/2"	24"	16	30"	16-250242	15-15/16"	16-250241
2-1/2"	24"	11	30"	11-250242	15-15/16"	11-250241
2-1/2"	36"	16	42"	16-250362	20-15/16"	16-250361
2-1/2"	36"	11	42"	11-250362	20-15/16"	11-250361
3"	24"	16	30"	16-300242	15-15/16"	16-300241
3"	24"	11	30"	11-300242	15-15/16"	11-300241
3"	30"	16	36"	16-300302	18-7/16"	16-300301
3"	30"	11	36"	11-300302	18-7/16"	11-300301
3"	36"	16	42"	16-300362	20-15/16"	16-300361
3"	36"	11	42"	11-300362	20-15/16"	11-300361
3"	38"	16	44"	16-300382	21-3/4"	16-300381
3"	38"	11	44"	11-300382	21-3/4"	11-300381
3"	48"	16	54"	16-300482	25-7/8"	16-300481
3"	48"	11	54"	11-300482	25-7/8"	11-300481
3-1/2"	30"	16	37"	16-350302	19-7/16"	16-350301
3-1/2"	30"	11	37"	11-350302	19-7/16"	11-350301
3-1/2"	36"	16	43"	16-350362	21-15/16"	16-350361
3-1/2"	36"	11	43"	11-350362	21-15/16"	11-350361
3-1/2"	48"	16	55"	16-350482	26-7/8"	16-350481
3-1/2"	48"	11	55"	11-350482	26-7/8"	11-350481
4"	24"	16	32"	16-400242	17-15/16"	16-400241
4"	24"	11	32"	11-400242	17-15/16"	11-400241
4"	30"	16	38"	16-400302	20-7/16"	16-400301
4"	30"	11	38"	11-400302	20-7/16"	11-400301
4"	36"	16	44"	16-400362	22-15/16"	16-400361
4"	36"	11	44"	11-400362	22-15/16"	11-400361
4"	48"	16	56"	16-400482	27-7/8"	16-400481
4"	48"	11	56"	11-400482	27-7/8"	11-400481
4"	60"	16	68"	16-400602	32-7/8"	16-400601
4"	60"	11	68"	11-400602	32-7/8"	11-400601
5"	30"	14	40"	14-500302	22-7/16"	14-500301
5"	30"	11	40"	11-500302	22-7/16"	11-500301
5"	48"	14	58"	14-500482	29-7/8"	14-500481
5"	48"	11	58"	11-500482	29-7/8"	11-500481
6"	30"	14	42"	14-600302	24-7/16"	14-600301
6"	30"	11	42"	11-600302	24-7/16"	11-600301
6"	48"	14	60"	14-600482	31-7/8"	14-600481
6"	48"	11	60"	11-600482	31-7/8"	11-600481
6"	60"	14	72"	14-600602	36-7/8"	14-600601
6"	60"	11	72"	11-600602	36-7/8"	11-600601
8"	32"	14	48"	14-800322	29-1/4"	14-800321
8"	32"	11	48"	11-800322	29-1/4"	11-800321
8"	48"	14	64"	14-800482	31-7/8"	14-800481
8"	48"	11	64"	11-800482	31-7/8"	11-800481
10"	48"	12	70"	12-1000482*	41-7/8"	12-1000481*

WHEN ORDERING,  
 PLEASE SPECIFY  
 TYPE OF MATERIAL

- Carbon
- Stainless
- Aluminum
- Galvanized Steel

• Nominal standard tangent is two times tube OD, 6" minimum • Nominal standard tangent for 10" bend is 22"  
 • All standard bends have straight ends • Stainless parts are segmented



## STANDARD 90° TY'S

- 2-1/8" through 14" OD
- Wall Thickness: 16, 14, 12, (11 Gauge Available in Straight Ends Only)
- (16 Gauge: 2-1/8" to 4" OD) (14 Gauge: 5" to 8" OD) (12 Gauge: 10" to 14" OD)
- Materials: Carbon, Stainless, Aluminum, Galvanized Steel

- 11 GAUGE TY'S AVAILABLE (STRAIGHT ENDS ONLY)
- STRAIGHT AND EXPANDED COMBINATIONS AVAILABLE
- STRAIGHT ENDS AVAILABLE ON ALL SIZES BY REQUEST

SIZE	GAUGE	A (OD)	B	C	F (OD)	H	K	PART NO.
2"	16	2"	5"	9-3/32"	2"	8-5/8"	9-1/2"	TY-204
2-1/8"	16	2-1/8"	5"	9-5/32"	2-1/8"	8-13/16"	9-1/2"	TY-215
2-1/2" x 2-1/8"	16	2-1/2"	5"	9-11/32"	2-1/8"	9"	10"	TY-255
2-1/2"	16	2-1/2"	6"	10-1/2"	2-1/2"	10-1/32"	10"	TY-256
3" x 2-1/8"	16	3"	5"	9-19/32"	2-1/8"	9-1/4"	10-1/2"	TY-305
3" x 2-1/2"	16	3"	6"	10-3/4"	2-1/2"	10-9/32"	10-1/2"	TY-306
3"	16	3"	7-1/2"	12-3/8"	3"	11-25/32"	11-1/2"	TY-307
3-1/2" x 2-1/8"	16	3-1/2"	5"	9-27/32"	2-1/8"	9-1/2"	11"	TY-355
3-1/2" x 2-1/2"	16	3-1/2"	6"	11"	2-1/2"	10-17/32"	11"	TY-356
3-1/2" x 3"	16	3-1/2"	7-1/2"	12-5/8"	3"	12-1/32"	13"	TY-357
3-1/2"	16	3-1/2"	8-3/4"	14-1/8"	3-1/2"	13-11/32"	13"	TY-358
4" x 2-1/8"	16	4"	5"	10-3/32"	2-1/8"	9-3/4"	12"	TY-405
4" x 2-1/2"	16	4"	6"	11-1/4"	2-1/2"	10-25/32"	12"	TY-406
4" x 3"	16	4"	7-1/2"	12-7/8"	3"	12-9/32"	12"	TY-407
4" x 3-1/2"	16	4"	8-3/4"	14-3/8"	3-1/2"	13-19/32"	14"	TY-408
4"	16	4"	10"	15-7/8"	4"	14-29/32"	14"	TY-409
5" x 2-1/8"	14	5"	5"	10-19/32"	2-1/8"	10-1/4"	13"	TY-505
5" x 2-1/2"	14	5"	6"	11-3/4"	2-1/2"	11-9/32"	13"	TY-506
5" x 3"	14	5"	7-1/2"	13-3/8"	3"	12-25/32"	15-1/2"	TY-507
5" x 3-1/2"	14	5"	8-3/4"	14-7/8"	3-1/2"	14-3/32"	15-1/2"	TY-508
5" x 4"	14	5"	10"	16-3/8"	4"	15-13/32"	15-1/2"	TY-509
5"	14	5"	12-1/2"	19-3/8"	5"	18-5/8"	18-1/2"	TY-515
6" x 2-1/8"	14	6"	5"	11-3/32"	2-1/8"	10-3/4"	15"	TY-605
6" x 2-1/2"	14	6"	6"	12-1/4"	2-1/2"	11-25/32"	15"	TY-606
6" x 3"	14	6"	7-1/2"	13-7/8"	3"	13-9/32"	15"	TY-607
6" x 3-1/2"	14	6"	8-3/4"	15-3/8"	3-1/2"	14-19/32"	17"	TY-608
6" x 4"	14	6"	10"	16-7/8"	4"	15-29/32"	17"	TY-609
6" x 5"	14	6"	12-1/2"	19-7/8"	5"	19-1/8"	21"	TY-614
6"	14	6"	15"	22-7/8"	6"	22-11/32"	21"	TY-615
8" x 2-1/8"	14	8"	5"	12-3/32"	2-1/8"	11-3/4"	18"	TY-805
8" x 2-1/2"	14	8"	6"	13-1/4"	2-1/2"	12-25/32"	18"	TY-806
8" x 3"	14	8"	7-1/2"	14-7/8"	3"	14-9/32"	18"	TY-807
8" x 3-1/2"	14	8"	8-3/4"	16-3/8"	3-1/2"	15-19/32"	21"	TY-808
8" x 4"	14	8"	10"	17-7/8"	4"	16-29/32"	21"	TY-809
8" x 5"	14	8"	12-1/2"	20-7/8"	5"	20-1/8"	24"	TY-814
8" x 6"	14	8"	15"	23-7/8"	6"	23-11/32"	24"	TY-815
8"	14	8"	20"	29-7/8"	8"	29-17/32"	29"	TY-816
10" x 2-1/8"	12	10"	5"	13-3/32"	2-1/8"	12-3/4"	21"	TY-1005

• EXPANDED ENDS STANDARD THROUGH 6" SIZE  
\* SEGMENTED

### KEY

OD = Outside Diameter  
 D = Expansion Depth 1-3/8" through 4" OD, 1-5/8" for 5" and 6" OD  
 A = Outside Diameter (OD) = E Inside Diameter (ID)  
 F = Outside Diameter (OD) = G Inside Diameter (ID)  
 L = Expansion Depth 1-3/8" through 4" OD, 1-5/8" for 5" and 6" OD  
 All reference dimensions are nominal.

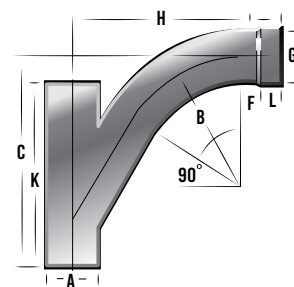

90° TY  
(ONE END EXPANDED)

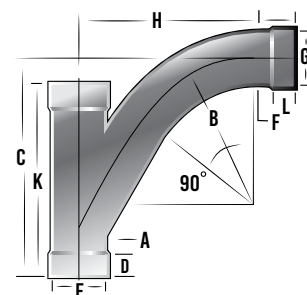

90° TY  
(THREE ENDS EXPANDED)

WHEN ORDERING,  
PLEASE SPECIFY  
TYPE OF MATERIAL

- Carbon
- Stainless
- Aluminum
- Galvanized Steel

## STANDARD 90° TY'S -CONT.

- 11 GAUGE TY'S AVAILABLE (STRAIGHT ENDS ONLY)
- STRAIGHT AND EXPANDED COMBINATIONS AVAILABLE
- STRAIGHT ENDS AVAILABLE ON ALL SIZES BY REQUEST

SIZE	GAUGE	A (OD)	B	C	F (OD)	H	K	PART NO.
10" x 2-1/2"	12	10"	6"	14-1/4"	2-1/2"	13-25/32"	21"	TY-1006
10" x 3"	12	10"	7-1/2"	15-7/8"	3"	15-9/32"	21"	TY-1007
10" x 3-1/2"	12	10"	8-3/4"	17-3/8"	3-1/2"	16-17/32"	24"	TY-1008
10" x 4"	12	10"	10"	18-7/8"	4"	17-29/32"	24"	TY-1009
10" x 5"	12	10"	12-1/2"	21-7/8"	5"	21-1/8"	24"	TY-1014
10" x 6"	12	10"	15"	24-7/8"	6"	24-11/32"	28"	TY-1015
10" x 8"	12	10"	20"	30-7/8"	8"	30-17/32"	32"	TY-1016
10"	12	10"	32"	40-3/8"	10"	42-25/32"	36"	TY-1017
12" x 2-1/8"	12	12"	5"	14-3/32"	2-1/8"	13-3/4"	24"	TY-1205
12" x 2-1/2"	12	12"	6"	15-1/4"	2-1/2"	14-25/32"	24"	TY-1206
12" x 3"	12	12"	7-1/2"	16-7/8"	3"	16-9/32"	24"	TY-1207
12" x 3-1/2"	12	12"	8-3/4"	18-3/8"	3-1/2"	17-19/32"	27"	TY-1208
12" x 4"	12	12"	10"	19-7/8"	4"	18-29/32"	27"	TY-1209
12" x 5"	12	12"	12-1/2"	22-7/8"	5"	22-1/8"	27"	TY-1214
12" x 6"	12	12"	15"	25-7/8"	6"	25-11/32"	31"	TY-1215
12" x 8"	12	12"	20"	31-7/8"	8"	31-17/32"	35"	TY-1216
12" x 10"	12	12"	32"	41-3/8"	10"	43-25/32"	39"	TY-1217
12"	12	12"	36"*	46-7/8"	12"	49-1/8"	43"	TY-1218
14" x 8"	12	14"	20"	32-7/8"	8"	32-17/32"	38"	TY-1416
14" x 10"	12	14"	32"	42-3/8"	10"	44-25/32"	42"	TY-1417
14" x 12"	12	14"	36"*	47-7/8"	12"	50-1/8"	46"	TY-1418
14"	12	14"	36"*	51-3/8"	14"	50-3/4"	52"	TY-1419

• EXPANDED ENDS STANDARD THROUGH 6" SIZE  
\* SEGMENTED

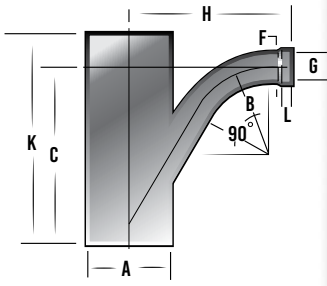

90° TY  
(ONE END EXPANDED)

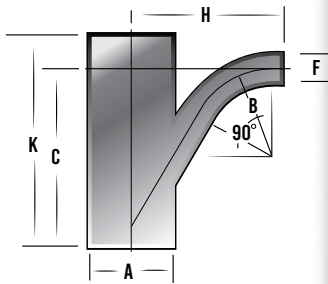

90° TY  
(STRAIGHT ENDS)

### WHEN ORDERING, PLEASE SPECIFY TYPE OF MATERIAL

- Carbon
- Stainless
- Aluminum
- Galvanized Steel

### KEY

OD = Outside Diameter  
F = Outside Diameter (OD) = G = Inside Diameter (ID)  
L = Expansion Depth 1-3/8" through 4" OD, 1-5/8" for 5" and 6" OD  
All reference dimensions are nominal.

# FITTINGS

## STANDARD 45° YL'S

- 2-1/8" through 14" OD
- Wall Thickness: 16, 14, 12, (11 Gauge Available in Straight Ends Only)
- (16 Gauge: 2-1/8" to 4" OD) (14 Gauge: 5" to 8" OD) (12 Gauge: 10" to 14" OD)
- Materials: Carbon, Stainless, Aluminum, Galvanized Steel
- 11 GAUGE YL'S AVAILABLE (STRAIGHT ENDS ONLY)
- STRAIGHT AND EXPANDED COMBINATIONS AVAILABLE
- STRAIGHT ENDS AVAILABLE ON ALL SIZES BY REQUEST

SIZE	GAUGE	A (OD)	B	C	F (OD)	H	K	PART NO.
2"	16	2"	5"	9-1/16"	2"	4-9/16"	9-1/2"	YL-2041
2-1/8"	16	2-1/8"	5"	9-3/32"	2-1/8"	4-11/16"	9-1/2"	YL-2151
2-1/2" X 2-1/8"	16	2-1/2"	5"	9-9/32"	2-1/8"	4-7/8"	10"	YL-2551
2-1/2"	16	2-1/2"	6"	10-5/32"	2-1/2"	5-3/16"	10"	YL-2561
3" X 2-1/8"	16	3"	5"	9-17/32"	2-1/8"	5-1/8"	10-1/2"	YL-3051
3" X 2-1/2"	16	3"	6"	10-13/32"	2-1/2"	5-7/16"	10-1/2"	YL-3061
3"	16	3"	7-1/2"	11-19/32"	3"	5-29/32"	11-1/2"	YL-3071
3-1/2" X 2-1/8"	16	3-1/2"	5"	9-25/32"	2-1/8"	5-3/8"	11"	YL-3551
3-1/2" X 2-1/2"	16	3-1/2"	6"	10-21/32"	2-1/2"	5-11/16"	11"	YL-3561
3-1/2" X 3"	16	3-1/2"	7-1/2"	11-27/32"	3"	6-5/32"	13"	YL-3571
3-1/2"	16	3-1/2"	8-3/4"	12-31/32"	3-1/2"	6-9/16"	13"	YL-3581
4" X 2-1/8"	16	4"	5"	10-1/32"	2-1/8"	5-5/8"	12"	YL-4051
4" X 2-1/2"	16	4"	6"	10-29/32"	2-1/2"	5-15/16"	12"	YL-4061
4" X 3"	16	4"	7-1/2"	12-3/32"	3"	6-13/32"	12"	YL-4071
4" X 3-1/2"	16	4"	8-3/4"	13-7/32"	3-1/2"	6-13/16"	14"	YL-4081
4"	16	4"	10"	14-11/32"	4"	7-1/4"	14"	YL-4091
5" X 2-1/8"	14	5"	5"	10-17/32"	2-1/8"	6-1/8"	13"	YL-5051
5" X 2-1/2"	14	5"	6"	11-13/32"	2-1/2"	6-7/16"	13"	YL-5061
5" X 3"	14	5"	7-1/2"	12-19/32"	3"	6-29/32"	15-1/2"	YL-5071
5" X 3-1/2"	14	5"	8-3/4"	13-23/32"	3-1/2"	7-5/16"	15-1/2"	YL-5081
5" X 4"	14	5"	10"	14-27/32"	4"	7-3/4"	15-1/2"	YL-5091
5"	14	5"	12-1/2"	17-9/16"	5"	9"	18-1/2"	YL-5151
6" X 2-1/8"	14	6"	5"	11-1/32"	2-1/8"	6-5/8"	15"	YL-6051
6" X 2-1/2"	14	6"	6"	11-29/32"	2-1/2"	6-15/16"	15"	YL-6061
6" X 3"	14	6"	7-1/2"	13-3/32"	3"	7-13/32"	15"	YL-6071
6" X 3-1/2"	14	6"	8-3/4"	14-7/32"	3-1/2"	7-13/16"	17"	YL-6081
6" X 4"	14	6"	10"	15-11/32"	4"	8-1/4"	17"	YL-6091
6" X 5"	14	6"	12-1/2"	18-1/16"	5"	9-1/2"	21"	YL-6141
6"	14	6"	15"	20-25/32"	6"	10-25/32"	21"	YL-6151
8" X 2-1/8"	14	8"	5"	12-1/32"	2-1/8"	7-5/8"	18"	YL-8051
8" X 2-1/2"	14	8"	6"	12-29/32"	2-1/2"	7-15/16"	18"	YL-8061
8" X 3"	14	8"	7-1/2"	14-3/32"	3"	8-13/32"	18"	YL-8071
8" X 3-1/2"	14	8"	8-3/4"	15-7/32"	3-1/2"	8-13/16"	21"	YL-8081
8" X 4"	14	8"	10"	16-11/32"	4"	9-1/4"	21"	YL-8091
8" X 5"	14	8"	12-1/2"	19-1/16"	5"	10-1/2"	24"	YL-8141
8" X 6"	14	8"	15"	21-25/32"	6"	11-25/32"	24"	YL-8151
8"	14	8"	20"	27"	8"	14-5/32"	29"	YL-8161
10" X 2-1/8"	12	10"	5"	13-1/32"	2-1/8"	8-5/8"	21"	YL-10051

• EXPANDED ENDS STANDARD THROUGH 6" SIZE  
\* SEGMENTED

### KEY

OD = Outside Diameter  
D = Expansion Depth 1-3/8" through 4" OD, 1-5/8" for 5" and 6" OD  
A = Outside Diameter (OD) = E Inside Diameter (ID)  
F = Outside Diameter (OD) = G Inside Diameter (ID)  
L = Expansion Depth 1-3/8" through 4" OD, 1-5/8" for 5" and 6" OD  
All reference dimensions are nominal.

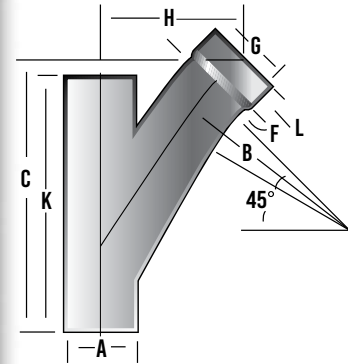

45° YL  
(ONE END EXPANDED)

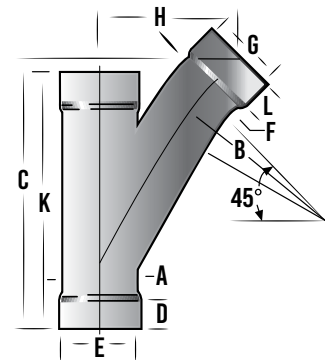

45° YL  
(THREE ENDS EXPANDED)

WHEN ORDERING,  
PLEASE SPECIFY  
TYPE OF MATERIAL

- Carbon
- Stainless
- Aluminum
- Galvanized Steel

## STANDARD 45° YL'S - CONT.

- 11 GAUGE YL'S AVAILABLE (STRAIGHT ENDS ONLY)
- STRAIGHT AND EXPANDED COMBINATIONS AVAILABLE
- STRAIGHT ENDS AVAILABLE ON ALL SIZES BY REQUEST

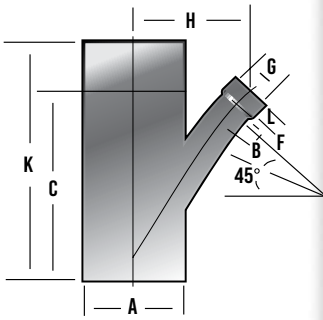

45° YL  
(ONE END EXPANDED)

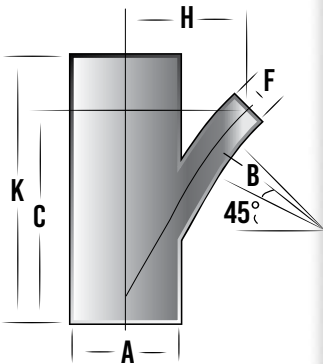

45° YL  
(THREE ENDS EXPANDED)

SIZE	GAUGE	A (OD)	B	C	F (OD)	H	K	PART NO.
10" X 2-1/2"	12	10"	6"	13-29/32"	2-1/2"	8-15/16"	21"	YL-10061
10" X 3"	12	10"	7-1/2"	15-3/32"	3"	9-13/32"	21"	YL-10071
10" X 3-1/2"	12	10"	8-3/4"	16-7/32"	3-1/2"	9-13/16"	24"	YL-10081
10" X 4"	12	10"	10"	17-11/32"	4"	10-1/4"	24"	YL-10091
10" X 5"	12	10"	12-1/2"	20-1/16"	5"	11-1/2"	24"	YL-10141
10" X 6"	12	10"	15"	22-3/4"	6"	12-25/32"	28"	YL-10151
10" X 8"	12	10"	20"	28"	8"	15-5/32"	32"	YL-10161
10"	12	10"	32"	34-11/16"	10"	18-5/8"	36"	YL-10171
12" X 2-1/8"	12	12"	5"	14-1/32"	2-1/8"	9-5/8"	24"	YL-12051
12" X 2-1/2"	12	12"	6"	14-29/32"	2-1/2"	9-31/32"	24"	YL-12061
12" X 3"	12	12"	7-1/2"	16-3/32"	3"	10-13/32"	24"	YL-12071
12" X 3-1/2"	12	12"	8-3/4"	17-7/32"	3-1/2"	10-13/16"	27"	YL-12081
12" X 4"	12	12"	10"	18-11/32"	4"	11-1/4"	27"	YL-12091
12" X 5"	12	12"	12-1/2"	21-1/16"	5"	12-1/2"	27"	YL-12141
12" X 6"	12	12"	15"	23-3/4"	6"	13-25/32"	31"	YL-12151
12" X 8"	12	12"	20"	29"	8"	16-5/32"	35"	YL-12161
12" X 10"	12	12"	32"	35-11/16"	10"	19-5/8"	39"	YL-12171
12"	12	12"	36"*	40-3/4"	12"	21-27/32"	43"	YL-12181
14" X 8"	12	14"	20"	30"	8"	17-5/32"	38"	YL-14161
14" X 10"	12	14"	32"	36-11/32"	10"	20-5/8"	42"	YL-14171
14" X 12"	12	14"	36"*	41-3/4"	12"	22-27/32"	46"	YL-14181
14"	12	14"	36"*	45-15/16"	14"	24-13/32"	52"	YL-14191

• EXPANDED ENDS STANDARD THROUGH 6" SIZE  
\* SEGMENTED

WHEN ORDERING,  
PLEASE SPECIFY  
TYPE OF MATERIAL

- Carbon
- Stainless
- Aluminum
- Galvanized Steel

### KEY

OD = Outside Diameter  
F = Outside Diameter (OD) = G = Inside Diameter  
L = Expansion Depth 1-3/8" through 4" OD, 1-5/8" for 5" and 6" OD  
All reference dimensions are nominal.

## STANDARD DOUBLE Y'S

- 2-1/8" through 6" OD
- Wall Thickness: 16, 14, (11 Gauge Available in Straight Ends Only)
- (16 Gauge: 2-1/8" to 4" OD) (14 Gauge: 5" to 6" OD)
- Materials: Carbon, Stainless, Aluminum, Galvanized Steel

## STANDARD DOUBLE 90° TY'S

- 11 GAUGE TY'S AVAILABLE (STRAIGHT ENDS ONLY)
- STRAIGHT AND EXPANDED COMBINATIONS AVAILABLE
- STRAIGHT ENDS AVAILABLE ON ALL SIZES BY REQUEST

SIZE	GAUGE	A (OD)	B	C	F (OD)	H	K	PART NO.
2-1/8"	16	2-1/8"	5"	9-5/32"	2-1/8"	8-13/16"	9-1/2"	DTY-215
2-1/2"	16	2-1/2"	6"	10-1/2"	2-1/2"	10-1/32"	10"	DTY-256
3"	16	3"	7-1/2"	12-3/8"	3"	11-25/32"	11-1/2"	DTY-307
3-1/2"	16	3-1/2"	8-3/4"	14-1/8"	3-1/2"	13-11/32"	13"	DTY-358
4"	16	4"	10"	15-7/8"	4"	14-29/32"	14"	DTY-409
5"	14	5"	12-1/2"	19-3/8"	5"	18-5/8"	18-1/2"	DTY-515
6"	14	6"	15"	22-7/8"	6"	22-11/32"	21"	DTY-615

• EXPANDED ENDS STANDARD

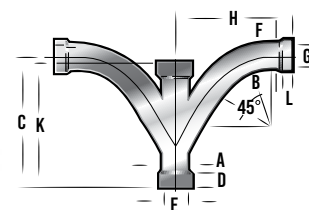

STANDARD DOUBLE 90° TY

## STANDARD DOUBLE 45° YL'S

- 11 GAUGE YL'S AVAILABLE (STRAIGHT ENDS ONLY)
- STRAIGHT AND EXPANDED COMBINATIONS AVAILABLE
- STRAIGHT ENDS AVAILABLE ON ALL SIZES BY REQUEST

SIZE	GAUGE	A (OD)	B	C	F (OD)	H	K	PART NO.
2-1/8"	16	2-1/8"	5"	9-3/32"	2-1/8"	4-11/16"	9-1/2"	DYL-2151
2-1/2"	16	2-1/2"	6"	10-5/32"	2-1/2"	5-3/16"	10"	DYL-2561
3"	16	3"	7-1/2"	11-19/32"	3"	5-29/32"	11-1/2"	DYL-3071
3-1/2"	16	3-1/2"	8-3/4"	12-31/32"	3-1/2"	6-9/16"	13"	DYL-3581
4"	16	4"	10"	14-11/32"	4"	7-1/4"	14"	DYL-4091
5"	14	5"	12-1/2"	17-9/16"	5"	9"	18-1/2"	DYL-5151
6"	14	6"	15"	20-25/32"	6"	10-15/32"	21"	DYL-6151

• EXPANDED ENDS STANDARD

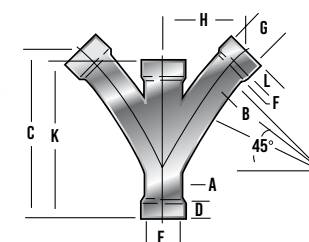

STANDARD DOUBLE 45° YL

## STANDARD DOUBLE 90° Y'S

- 11 GAUGE Y'S AVAILABLE (STRAIGHT ENDS ONLY)
- STRAIGHT AND EXPANDED COMBINATIONS AVAILABLE
- STRAIGHT ENDS AVAILABLE ON ALL SIZES BY REQUEST

SIZE	GAUGE	A (OD)	B	C	F (OD)	H	K	PART NO.
2-1/8"	16	2-1/8"	5"	7"	2-1/8"	7"	-	DY-215
2-1/2"	16	2-1/2"	6"	8"	2-1/2"	8"	-	DY-256
3"	16	3"	7-1/2"	9-1/2"	3"	9-1/2"	-	DY-307
3-1/2"	16	3-1/2"	8-3/4"	10-3/4"	3-1/2"	10-3/4"	-	DY-358
4"	16	4"	10"	12"	4"	12"	-	DY-409
5"	14	5"	12-1/2"	15-1/8"	5"	15-1/8"	-	DY-515
6"	14	6"	15"	18-1/4"	6"	18-1/4"	-	DY-615

• EXPANDED ENDS STANDARD

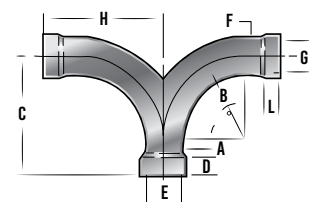

STANDARD DOUBLE 90° Y

### KEY

OD = Outside Diameter  
 D = Expansion Depth 1-3/8" through 4" OD, 1-5/8" for 5" and 6" OD  
 A = Outside Diameter (OD) = E Inside Diameter (ID)  
 F = Outside Diameter (OD) = G Inside Diameter (ID)  
 L = Expansion Depth 1-3/8" through 4" OD, 1-5/8" for 5" and 6" OD  
 All reference dimensions are nominal.

**WHEN ORDERING,  
PLEASE SPECIFY  
TYPE OF MATERIAL**

- Carbon
- Stainless
- Aluminum
- Galvanized Steel

## STANDARD REDUCING COUPLINGS

- 2-1/8" through 14" OD
- Wall Thickness: 16, 14, 12, (11 Gauge Available in Straight Ends Only)
- Materials: Carbon, Stainless, Aluminum, Galvanized Steel
- 11 GAUGE AVAILABLE (STRAIGHT ENDS ONLY)
- STRAIGHT ENDS AVAILABLE ON ALL SIZES BY REQUEST

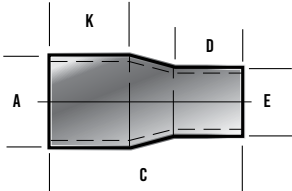

STANDARD REDUCING COUPLING  
(STRAIGHT END)

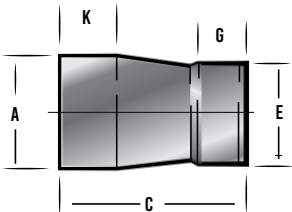

STANDARD REDUCING COUPLING  
(EXPANDED END)

### Other sizes available.

Please call a Customer Service Representative for information.

### WHEN ORDERING, PLEASE SPECIFY TYPE OF MATERIAL

- Carbon
- Stainless
- Aluminum
- Galvanized Steel

SIZE	GAUGE	A (OD)	C	D	E (ID)	F (OD)	G	K	PART NO.
2-1/8" x 2"	16	2-1/8"	4"	1-25/32"	2" ID	-	1-1/8"	2"	RC-212
2-1/2" x 2-1/8"	16	2-1/2"	4-1/2"	1-3/4"	2-1/8" ID	-	1-3/8"	1-1/2"	RC-254
3" x 2-1/8"	16	3"	8-3/4"	2-1/4"	2-1/8" ID	-	1-3/8"	2"	RC-3041
3" x 2-1/2"	16	3"	5"	2"	2-1/2" ID	-	1-3/8"	1-1/2"	RC-304
3-1/2" X 2-1/8"	16	3-1/2"	11"	2-1/4"	2-1/8" ID	-	1-3/8"	2"	RC-3541
3-1/2" X 2-1/2"	16	3-1/2"	9-1/4"	2-7/8"	2-1/2" ID	-	1-3/8"	2-7/8"	RC-3542
3-1/2" X 3"	16	3-1/2"	5-1/2"	2-1/8"	3" ID	-	1-3/8"	2-1/8"	RC-354
4" X 2-1/8"	16	4"	13-1/2"	1-5/8"	2-1/8" ID	-	1-3/8"	2"	RC-4041
4" X 2-1/2"	16	4"	10-1/2"	2-1/4"	2-1/2" ID	-	1-3/8"	2"	RC-4042
4" X 3"	16	4"	9-1/4"	2-1/4"	3" ID	-	1-3/8"	2"	RC-4043
4" X 3-1/2"	16	4"	6"	2"	3-1/2" ID	-	1-3/8"	1-1/2"	RC-404
5" X 2-1/8"	14	5"	19-1/4"	2-1/4"	2-1/8" ID	-	1-3/8"	2-3/4"	RC-5041
5" X 2-1/2"	14	5"	17-1/2"	2-1/4"	2-1/2" ID	-	1-3/8"	2-3/4"	RC-5042
5" X 3"	14	5"	15"	2-1/4"	3" ID	-	1-3/8"	2-3/4"	RC-5043
5" X 3-1/2"	14	5"	12-1/2"	2-1/4"	3-1/2" ID	-	1-3/8"	2-3/4"	RC-5044
5" X 4"	16	5"	8"	2-1/4"	4" ID	-	1-3/8"	1-3/4"	RC-504
6" X 2-1/8"	14	6"	24-3/4"	2-1/4"	2-1/8" ID	-	1-3/8"	3-1/4"	RC-6041
6" X 2-1/2"	14	6"	23"	2-1/4"	2-1/2" ID	-	1-3/8"	3-1/4"	RC-6042
6" X 3"	14	6"	20-1/2"	2-1/4"	3" ID	-	1-3/8"	3-1/4"	RC-6043
6" X 3-1/2"	14	6"	18"	2-1/4"	3-1/2" ID	-	1-3/8"	3-1/4"	RC-6044
6" X 4"	14	6"	15-3/4"	2-1/4"	4" ID	-	1-3/8"	3-1/4"	RC-6045
6" X 5"	14	6"	10"	2-5/8"	5" ID	-	1-3/8"	1-3/4"	RC-604
8" X 4"	14	8"	26-1/4"	2"	4" ID	-	1-3/8"	4-1/4"	RC-8044
8" X 5"	14	8"	21-7/8"	2-5/8"	5" ID	-	1-5/8"	4-1/4"	RC-8045
8" X 6"	14	8"	16-1/2"	3-1/4"	6" ID	-	1-5/8"	3-5/8"	RC-804
10" X 6"	12	10"	28-1/2"	3-1/4"	6" ID	-	1-5/8"	5-1/4"	RC-10046
10" X 8"	12	10"	18-1/4"	2-1/2"	-	8" OD	N/A	5-1/4"	RC-1004
12" X 8"	12	12"	29-1/4"	2-1/2"	-	8" OD	N/A	6-1/4"	RC-12048
12" X 10"	12	12"	19-3/4"	3-1/4"	-	10" OD	N/A	6"	RC-1204
14" X 10"	12	14"	30"	3"	-	10" OD	N/A	7-1/4"	RC-1404
14" X 12"	12	14"	20"	4"	-	12" OD	N/A	7-1/4"	RC-1405

• EXPANDED ENDS STANDARD THROUGH 6" SIZE (ON SMALL END OF REDUCER)

### KEY

OD = Outside Diameter  
ID = Inside Diameter  
All reference dimensions are nominal.  
G = Expansion Depth

## STANDARD ADAPTERS

- 2" to 12"
- Wall Thickness: 16, 14, 12, 11 Gauge
- Materials: Carbon, Stainless, Aluminum, Galvanized Steel

## FEMALE ADAPTERS - STRAIGHT

• 11 GAUGE AVAILABLE

SIZE	GAUGE	A-FNPT	C	F (OD)	PART NO.
2" to 2"	16	2"	6"	2"	FA-201
2" to 2-1/8"	16	2"	6"	2-1/8"	FA-211
2-1/2" to 2-1/2"	16	2-1/2"	6"	2-1/2"	FA-251
3" to 3"	16	3"	6"	3"	FA-301
3-1/2" to 3-1/2"	16	3-1/2"	6"	3-1/2"	FA-351
4" to 4"	16	4"	6-1/2"	4"	FA-401
5" to 5"	14	5"	6-3/4"	5"	FA-501
6" to 6"	14	6"	7"	6"	FA-601
8" to 8"	14	8"	9"	8"	FA-801
10" to 10"	12	10"	11"	10"	FA-1001
12" to 12"	12	12"	13"	12"	FA-1201

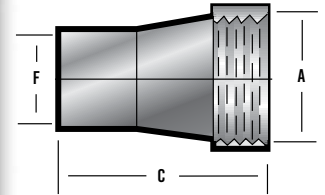

FEMALE ADAPTER

### KEY

FNPT = Female National Pipe Thread  
 OD = Outside Diameter  
 MNPT = Male National Pipe Thread  
 ID = Inside Diameter  
 All reference dimensions are nominal.

## MALE ADAPTERS - STRAIGHT

• 11 GAUGE AVAILABLE

SIZE	GAUGE	A-MNPT	C	F (OD)	PART NO.
2" to 2"	16	2"	6"	2"	MA-202
2" to 2-1/8"	16	2"	6"	2-1/8"	MA-212
2-1/2" to 2-1/2"	16	2-1/2"	6"	2-1/2"	MA-252
3" to 3"	16	3"	6"	3"	MA-302
3-1/2" to 3-1/2"	16	3-1/2"	6"	3-1/2"	MA-352
4" to 4"	16	4"	6"	4"	MA-402
5" to 5"	14	5"	6-1/2"	5"	MA-502
6" to 6"	14	6"	7"	6"	MA-602
8" to 8"	14	8"	8"	8"	MA-802
10" to 10"	12	10"	8-1/2"	10"	MA-1002
12" to 12"	12	12"	9"	12"	MA-1202

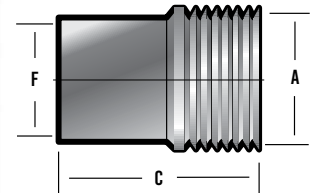

MALE ADAPTER

**WHEN ORDERING,  
PLEASE SPECIFY  
TYPE OF MATERIAL**

- Carbon
- Stainless
- Aluminum
- Galvanized Steel

## MALE ADAPTERS - STRAIGHT

- 2-1/8"
- Materials: Carbon, Stainless, Aluminum, Galvanized Steel

SIZE	A-MNPT	C	D	F (ID)	F (OD)	PART NO.
2-1/8" x 1-1/4"	1-1/4"	5-3/4"	-	-	2-1/8"	MA-16
2-1/8" x 1-1/2"	1-1/2"	5-3/4"	-	-	2-1/8"	MA-17
2-1/8" x 1-1/4"	1-1/4"	5-3/4"	1-1/4"*	2-1/8"	-	MA-18
2-1/8" x 1-1/2"	1-1/2"	5-3/4"	1-1/4"*	2-1/8"	-	MA-19

\* EXPANSION DEPTH

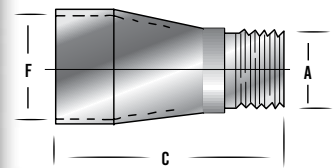

MALE ADAPTER

## STANDARD ADAPTERS - CONT.

### FEMALE AND MALE ADAPTERS - EXPANDED

- 2" to 6"
- Wall Thickness: 16, 14, 12 Gauge
- Materials: Carbon, Stainless, Aluminum, Galvanized Steel

### FEMALE ADAPTERS - EXPANDED

SIZE	GAUGE	A-FNPT	C	D	E (ID)	PART NO.
2" to 2"	16	2"	6"	1-1/8"	2"	FA-203
2" to 2-1/8"	16	2"	6"	1-3/8"	2-1/8"	FA-213
2-1/2" to 2-1/2"	16	2-1/2"	6"	1-3/8"	2-1/2"	FA-253
3" to 3"	16	3"	6"	1-3/8"	3"	FA-303
3-1/2" to 3-1/2"	16	3-1/2"	6"	1-3/8"	3-1/2"	FA-353
4" to 4"	16	4"	6-1/2"	1-3/8"	4"	FA-403
5" to 5"	14	5"	6-3/4"	1-5/8"	5"	FA-503
6" to 6"	14	6"	7"	1-5/8"	6"	FA-603

### MALE ADAPTERS - EXPANDED

SIZE	GAUGE	A-MNPT	C	D	E (ID)	PART NO.
2" to 2"	16	2"	6"	1-1/8"	2"	MA-204
2" to 2-1/8"	16	2"	6"	1-3/8"	2-1/8"	MA-214
2-1/2" to 2-1/2"	16	2-1/2"	6"	1-3/8"	2-1/2"	MA-254
3" to 3"	16	3"	6"	1-3/8"	3"	MA-304
3-1/2" to 3-1/2"	16	3-1/2"	6"	1-3/8"	3-1/2"	MA-354
4" to 4"	16	4"	6"	1-3/8"	4"	MA-404
5" to 5"	14	5"	6-1/2"	1-5/8"	5"	MA-504
6" to 6"	14	6"	7"	1-5/8"	6"	MA-604

### 90° ADAPTER ELBOW

- 2-1/8" to 2"
- Available only in Cast Gray Iron, Zinc, Nickel Plated or Cast Aluminum

SIZE	C	D	E (ID)	H	L-FNPT	PART NO.
2-1/8" to 2"	2-9/16"	1-3/8"	2-1/8"	1-5/8"	2"	AE-211*

\* AVAILABLE ONLY IN CAST GRAY IRON, ZINC, NICKEL PLATED OR CAST ALUMINUM

### ADAPTER TEES

- 2-1/8" to 4"
- 11 GAUGE ADAPTERS AVAILABLE

SIZE	C	D	E (ID)	H	L-FNPT	PART NO.
2-1/8" to 2"	4-13/16"	1-3/8"	2-1/8"	1-9/16"	2"	AT-212*
2-1/2" to 2"	6-1/2"	1-3/8"	2-1/2"	2-1/8"	2"	AT-250
3" to 2"	6-1/2"	1-3/8"	3"	2-3/4"	2"	AT-302
3-1/2" to 2"	6-7/8"	1-3/8"	3-1/2"	3-7/16"	2"	AT-352
4" to 2"	6-7/8"	1-3/8"	4"	3-7/16"	2"	AT-402

\* AVAILABLE ONLY IN CAST GRAY IRON, ZINC, NICKEL PLATED OR CAST ALUMINUM & NOT 11 GAUGE

WHEN ORDERING,  
PLEASE SPECIFY  
TYPE OF MATERIAL

- Carbon
- Stainless
- Aluminum
- Galvanized Steel

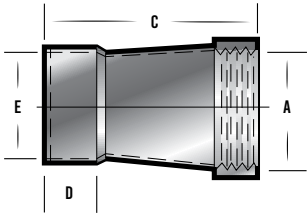

FEMALE ADAPTER

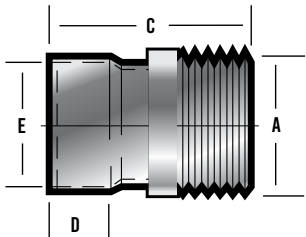

MALE ADAPTER EXPANDED

#### KEY

FNPT = Female National Pipe Thread  
ID = Inside Diameter  
MNPT = Male National Pipe Thread  
All reference dimensions are nominal.

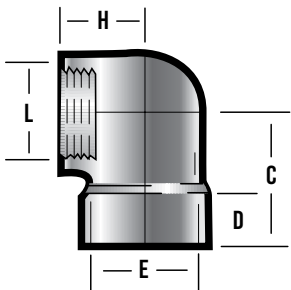

90° ADAPTER ELBOW

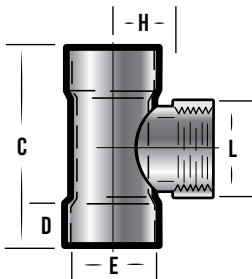

ADAPTER TEE



## STANDARD ADAPTERS - CONT.

### MALE ADAPTER NIPPLE

- 2-1/8"
- Materials: Carbon, Stainless, Aluminum, Galvanized Steel

SIZE	A-MNPT	C	E (ID)	PART NO.
2-1/8"	2"	2"	2-1/8"	MA-20

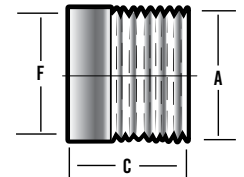

MALE ADAPTER NIPPLE

### FEMALE REDUCING ADAPTER

- 2" to 2-1/2"
- Wall Thickness: 16 Gauge
- Materials: Carbon, Stainless, Aluminum, Galvanized Steel

SIZE	GAUGE	A-FNPT	C	F (OD)	PART NO.
2" to 2-1/2"	16	2"	4-1/4"	2-1/2"	FA-205

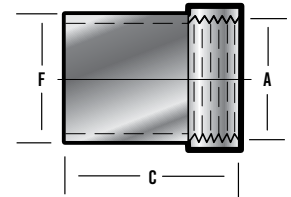

FEMALE REDUCING ADAPTER

### FEMALE REDUCING ADAPTER EXPANDED

- 2" to 2-1/2"
- Wall Thickness: 16 Gauge

SIZE	GAUGE	A-FNPT	C	D	E (ID)	PART NO.
2" to 2-1/2"	16	2"	4-1/4"	1-3/8"	2-1/2"	FA-206

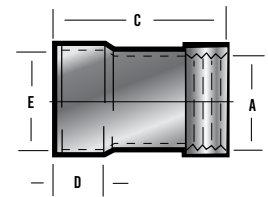

FEMALE REDUCING ADAPTER EXPANDED

### 45° FEMALE ADAPTER ELBOW

- 2-1/8" to 2-1/2" OD
- Wall Thickness: 16, (11 Gauge Available in Straight Ends Only)
- Materials: Carbon, Stainless, Aluminum, Galvanized Steel

SIZE	A (OD)	GAUGE	B	C	D	E (ID)	L-FNPT	PART NO.
2-1/8" to 2"	2-1/8"	16	5"	4-1/16"	1-3/8"	2-1/8"	2"	AE-2111
2-1/2" to 2"	2-1/2"	16	6"	4-1/2"	1-3/8"	2-1/2"	2"	AE-2511
2-1/2" to 2-1/2"	2-1/2"	16	6"	4-1/2"	1-3/8"	2-1/2"	2-1/2"	AE-2512

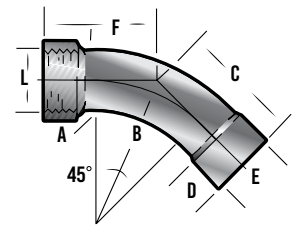

45° FEMALE ADAPTER ELBOW

#### KEY

MNPT = Male National Pipe Thread  
 ID = Inside Diameter  
 FNPT = Female National Pipe Thread  
 OD = Outside Diameter  
 All reference dimensions are nominal.

**WHEN ORDERING,  
 PLEASE SPECIFY  
 TYPE OF MATERIAL**

- Carbon
- Stainless
- Aluminum
- Galvanized Steel

# METHODS OF JOINING

All reference dimensions are nominal

## SLIP COUPLINGS

Can be used for joining any two straight ends of tubing or fittings. The slip coupling is a solid sleeve that fits the OD of the joint which can then be glued, brazed, welded, or covered by shrink sleeves.

- 2-1/8" through 14" OD
- Wall Thickness: 16, 14, 12 Gauge
- Materials: Carbon, Stainless, Aluminum, Galvanized Steel

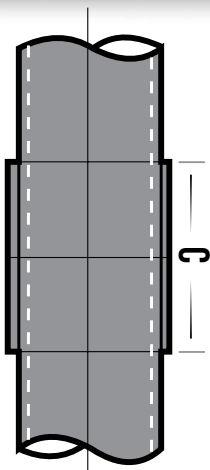

SLIP COUPLING

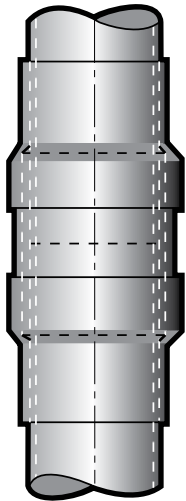

SHRINK SLEEVES

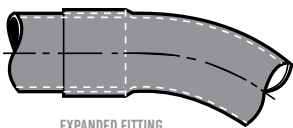

EXPANDED FITTING

SIZE	C	ID	GAUGE	PART NO.
2"	3"	2"	16	SC-203
2-1/8"	3"	2-1/8"	16	SC-213
2-1/2"	3-1/2"	2-1/2"	16	SC-253
3"	4"	3"	16	SC-303
3-1/2"	4-1/2"	3-1/2"	16	SC-353
4"	5"	4"	16	SC-403
5"	6"	5"	14	SC-503
6"	7"	6"	14	SC-603*
8"	8"	8"	14	SC-803
10"	10"	10"	12	SC-1003
12"	12"	12"	12	SC-1203
14"	14"	14"	12	SC-1403

• JOINING METHODS ARE FOR USE IN LOW PRESSURE (UNDER 15 PSIG) SYSTEMS  
\* 6" GALVANIZED SLIP COUPLING IS 16 GAUGE. ALL OTHER MATERIALS ARE 14 GAUGE

## SHRINK SLEEVES

A heat shrinkable polyolefin band that literally shrinks and encircles the connection giving it mechanical strength and a positive seal. It can be used in conjunction with a slip coupling or when using expanded fittings. Gluing, brazing and welding operations are eliminated.

FOR TUBE OD SIZE	SLEEVE LENGTH	PART NO.
2" - 2-1/8"	4"	SS-212
2-1/2" - 3"	4-1/2"	SS-300
3-1/2" - 4"	4-1/2"	SS-400
5"	4-1/2"	SS-500
6"	4-1/2"	SS-600
8"	9"	SS-800
10"	9"	SS-1000
12"	9"	SS-1200
14"	9"	SS-1400

• JOINING METHODS ARE FOR USE IN LOW PRESSURE (UNDER 15 PSIG) SYSTEMS

## WRAPPED SLEEVE

This kit contains a sheet of black material 18" wide and a sealing strip. The wrapped sleeve comes in a polyolefin shell with a semicrystalline adhesive.

WIDTH	TUBE LENGTH	PART NO.
18"	14"	WS-1400

## EXPANDED FITTINGS

This type of connection enables a straight section of tubing to slip inside the expanded end of the fitting. The two pieces can then be "locked" together by any one of several techniques - brazing, welding, industrial adhesive or shrink sleeves. Not available in 11 gauge material. Joining methods are for use in low pressure (under 15 PSIG) systems.

### WHEN ORDERING, PLEASE SPECIFY TYPE OF MATERIAL

- Carbon
- Stainless
- Aluminum
- Galvanized Steel

### KEY

OD = Outside Diameter  
ID = Inside Diameter  
PSIG = Pounds per Square Inch Gravity  
All reference dimensions are nominal.

# METHODS OF JOINING

## INSTALOCK

- Couplings are made of galvanized steel
- Standard O-ring is black nitrile
- Also offering replacement O-rings, nuts, bolts and clamps

OD	NPS	O-RING	LENGTH (IN.)	PART NO.
1-1/2"	-	Black	4	CP15042B-16Z
1-1/2"	-	White	4	CP15042W-16Z
1-1/2"	-	Black	6	CP15062B-16Z
1-1/2"	-	White	6	CP15062W-16Z
1-3/4"	-	Black	4	CP17542B-16Z
1-3/4"	-	White	4	CP17542W-16Z
1-3/4"	-	Black	6	CP17562B-16Z
1-3/4"	-	White	6	CP17562W-16Z
2"	-	Black	4	CP20042B-16Z
2"	-	White	4	CP20042W-16Z
2"	-	Black	6	CP20062B-16Z
2"	-	White	6	CP20062W-16Z
2-1/8"	-	Black	4	CP21242B-16Z
2-1/8"	-	White	4	CP21242W-16Z
2-1/8"	-	Black	6	CP21262B-16Z
2-1/8"	-	White	6	CP21262W-16Z
2-1/4"	-	Black	4	CP22542B-16Z
2-1/4"	-	White	4	CP22542W-16Z
2-1/4"	-	Black	6	CP22562B-16Z
2-1/4"	-	White	6	CP22562W-16Z
2-3/8"	2"	Black	4	CP237542B-16Z
2-3/8"	2"	White	4	CP237542W-16Z
2-3/8"	2"	Black	6	CP237562B-16Z
2-3/8"	2"	White	6	CP237562W-16Z
2-3/8"	2"	Black	8	CP237582B-16Z
2-3/8"	2"	White	8	CP237582W-16Z
2-1/2"	-	Black	4	CP25042B-16Z
2-1/2"	-	White	4	CP25042W-16Z
2-1/2"	-	Black	6	CP25062B-16Z
2-1/2"	-	White	6	CP25062W-16Z
2-1/2"	-	Black	8	CP25082B-16Z
2-1/2"	-	White	8	CP25082W-16Z
2-7/8"	2-1/2"	Black	4	CP287542B-16Z
2-7/8"	2-1/2"	White	4	CP287542W-16Z
2-7/8"	2-1/2"	Black	6	CP287562B-16Z
2-7/8"	2-1/2"	White	6	CP287562W-16Z
2-7/8"	2-1/2"	Black	8	CP287582B-16Z
2-7/8"	2-1/2"	White	8	CP287582W-16Z

## INSTALOK™

### Specifications

- 1-1/2" OD to 4" OD
- 20% Lower cost than traditional couplings
- 30% Quicker installation
- Couplings have a unique clamping design that offers unparalleled strength and grip
- Made with Grade 5 stress relieved bolts to ensure durability
- Standard O-ring is black nitrile
- Galvanized Steel Construction

*We also offer replacement O-rings, nuts, bolts and clamps*

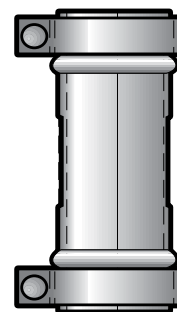

# METHODS OF JOINING

All reference dimensions are nominal

## INSTALOCK

- Couplings are made of galvanized steel
- Standard O-ring is black nitrile
- Also offering replacement O-rings, nuts, bolts and clamps

OD	NPS	O-RING	LENGTH (IN.)	PART NO.
3"	-	Black	4	CP30042B-16Z
3"	-	White	4	CP30042W-16Z
3"	-	Black	6	CP30062B-16Z
3"	-	White	6	CP30062W-16Z
3"	-	Black	8	CP30082B-16Z
3"	-	White	8	CP30082W-16Z
3-1/2"	3"	Black	4	CP35042B-16Z
3-1/2"	3"	White	4	CP35042W-16Z
3-1/2"	3"	Black	6	CP35062B-16Z
3-1/2"	3"	White	6	CP35062W-16Z
3-1/2"	3"	Black	8	CP35082B-16Z
3-1/2"	3"	White	8	CP35082W-16Z
4"	3-1/2"	Black	4	CP40042B-16Z
4"	3-1/2"	White	4	CP40042W-16Z
4"	3-1/2"	Black	6	CP40062B-16Z
4"	3-1/2"	White	6	CP40062W-16Z
4"	3-1/2"	Black	8	CP40082B-16Z
4"	3-1/2"	White	8	CP40082W-16Z

### INSTALOK™ Dust Cap

#### Specifications

- 1-1/2" OD to 4" OD
- Utilizes the same unique clamping design as the INSTALOK Coupling
- Great for sealing exposed/unused material handling lines
- Non-permanent and completely reusable

We also offer replacement O-rings, nuts, and bolts

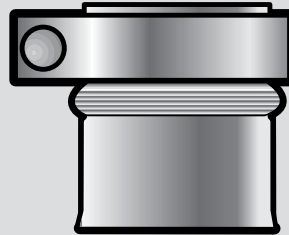

## INSTALOK DUST CAPS

OD	NPS	O-RING	LENGTH	PRODUCT ID
1-1/2"		Black	3"	DC-150-B
1-3/4"		Black	3"	DC-175-B
2"		Black	3"	DC-200-B
2-1/8"		Black	3"	DC-212-B
2-1/4"		Black	3"	DC-225-B
2-1/2"		Black	3"	DC-250-B
3"		Black	3"	DC-300-B
3-1/2"	3"	Black	3"	DC-350-B
4"	3-1/2"	Black	3"	DC-400-B

#### KEY

OD = Outside Diameter  
 NPS = Nominal Pipe Size  
 All reference dimensions are nominal.

# METHODS OF JOINING

## COMPRESSION COUPLINGS

### "Our own signature coupling"

- Straight end tubing or fittings butt together within the ID of the coupling, and the joint is mechanically locked simply by tightening the bolts.
- 2-1/8" to 14" OD
- Standard Material is Galvanized Steel
- Standard Coupling includes Black Neoprene Gasket & Stainless Steel Grounding Strip.

- WE ARE ALSO CAPABLE OF STAINLESS COMPRESSION COUPLINGS
- OTHER GASKETS AVAILABLE: WHITE NITRILE, RED RUBBER, SILICONE, EPDM AND VITON
- STAINLESS STEEL GASKET PROTECTORS ARE ALSO AVAILABLE
- WE CAN FURNISH YOU WITH REPLACEMENT NUTS, BOLTS, GASKETS AND STATIC STRIPS

OD	NO. BOLT	GASKET	PROTECTOR	COUPLING LENGTH	PART NO.
2-1/8"	2	BLACK	-	4	21252B10
2-1/8"	2	BLACK	YES	4	21252B11
2-1/8"	3	BLACK	-	6	21253B10
2-1/8"	3	BLACK	YES	6	21253B11
2-1/2"	2	BLACK	-	4	25002B10
2-1/2"	2	BLACK	YES	4	25002B11
2-1/2"	3	BLACK	-	6	25003B10
2-1/2"	3	BLACK	YES	6	25003B11
2-1/2"	4	BLACK	-	8	25004B10
2-1/2"	4	BLACK	YES	8	25004B11
3"	2	BLACK	-	4	30002B10
3"	2	BLACK	YES	4	30002B11
3"	3	BLACK	-	6	30003B10
3"	3	BLACK	YES	6	30003B11
3"	4	BLACK	-	8	30004B10
3"	4	BLACK	YES	8	30004B11
3-1/2"	2	BLACK	-	4	35002B10
3-1/2"	2	BLACK	YES	4	35002B11
3-1/2"	3	BLACK	-	6	35003B10
3-1/2"	3	BLACK	YES	6	35003B11
3-1/2"	4	BLACK	-	8	35004B10
3-1/2"	4	BLACK	YES	8	35004B11
4"	2	BLACK	-	4	40002B10
4"	2	BLACK	YES	4	40002B11
4"	3	BLACK	-	6	40003B10
4"	3	BLACK	YES	6	40003B11
4"	4	BLACK	-	8	40004B10
4"	4	BLACK	YES	8	40004B11
5"	2	BLACK	-	4	50002B10
5"	2	BLACK	YES	4	50002B11
5"	3	BLACK	-	6	50003B10
5"	3	BLACK	YES	6	50003B11
5"	4	BLACK	-	8	50004B10

- FOR COUPLINGS 1-1/4" THROUGH 2-7/8" OD THE BOLT SIZE IS 1/2" X 2"
- FOR COUPLINGS 3" THROUGH 7-1/2" OD THE BOLT SIZE IS 5/8" X 2-1/4"
- FOR COUPLINGS 8" THROUGH 14" OD THE BOLT SIZE IS 3/4" X 3"
- JOINING METHODS ARE FOR USE IN LOW PRESSURE (UNDER 15 PSIG) SYSTEMS

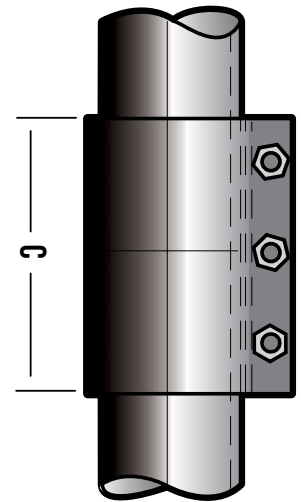

COMPRESSION  
COUPLING

### KEY

ID = Inside Diameter  
OD = Outside Diameter

All reference dimensions  
are nominal.

# METHODS OF JOINING

All reference dimensions are nominal

## COMPRESSION COUPLINGS - CONT.

*"Our own signature coupling"*

- WE ARE ALSO CAPABLE OF STAINLESS COMPRESSION COUPLINGS
- OTHER GASKETS AVAILABLE: WHITE NITRILE, RED RUBBER, SILICONE, EPDM AND VITON
- STAINLESS STEEL GASKET PROTECTORS ARE ALSO AVAILABLE
- WE CAN FURNISH YOU WITH REPLACEMENT NUTS, BOLTS, GASKETS AND STATIC STRIPS

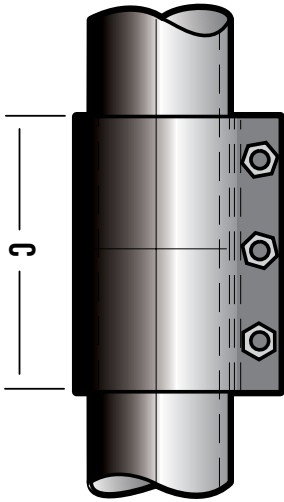

COMPRESSION  
COUPLING

OD	NO. BOLT	GASKET	PROTECTOR	COUPLING LENGTH	PART NO.
5"	4	BLACK	YES	8	50004B11
6"	2	BLACK	-	4	60002B10
6"	2	BLACK	YES	4	60002B11
6"	3	BLACK	-	6	60003B10
6"	3	BLACK	YES	6	60003B11
6"	4	BLACK	-	8	60004B10
6"	4	BLACK	YES	8	60004B11
6"	5	BLACK	-	10	60005B10
6"	5	BLACK	YES	10	60005B11
8"	2	BLACK	-	6	80002B10
8"	2	BLACK	YES	6	80002B11
8"	3	BLACK	-	8	80003B10
8"	3	BLACK	YES	8	80003B11
8"	4	BLACK	-	10	80004B10
8"	4	BLACK	YES	10	80004B11
8"	5	BLACK	-	12	80005B10
8"	5	BLACK	YES	12	80005B11
10"	3	BLACK	-	8	100003B10
10"	3	BLACK	YES	8	100003B11
10"	4	BLACK	-	10	100004B10
10"	4	BLACK	YES	10	100004B11
10"	5	BLACK	-	12	100005B10
10"	5	BLACK	YES	12	100005B11
12"	3	BLACK	-	8	120003B10
12"	3	BLACK	YES	8	120003B11
12"	4	BLACK	-	10	120004B10
12"	4	BLACK	YES	10	120004B11
12"	5	BLACK	-	12	120005B10
12"	5	BLACK	YES	12	120005B11
14"	4	BLACK	-	10	140004B10
14"	4	BLACK	YES	10	140004B11
14"	5	BLACK	-	12	140005B10
14"	5	BLACK	YES	12	140005B11

### KEY

OD = Outside Diameter

All reference dimensions are nominal.

• FOR COUPLINGS 1-1/4" THROUGH 2-7/8" OD THE BOLT SIZE IS 1/2" X 2"  
 • FOR COUPLINGS 3" THROUGH 7-1/2" OD THE BOLT SIZE IS 5/8" X 2-1/4"  
 • FOR COUPLINGS 8" THROUGH 14" OD THE BOLT SIZE IS 3/4" X 3"  
 • JOINING METHODS ARE FOR USE IN LOW PRESSURE (UNDER 15 PSIG) SYSTEMS

# METHODS OF JOINING

## SLIP WELDING RINGS

- 8" to 14" OD
- Materials: Carbon, Stainless, Aluminum, Galvanized Steel

SIZE	C	E (ID)	GAUGE	PART NO.
8"	3"	8"	14	WR-8035
10"	3"	10"	12	WR-10035
12"	3"	12"	12	WR-12035
14"	3"	14"	12	WR-14035

## TUBE PLUGS

- 2-1/8" to 14" OD/ID
- Wall Thickness: 16, 14, 12 Gauge
- AVAILABLE IN 11 GAUGE

SIZE	A (OD)/(ID)	GAUGE	C	PART NO.
2-1/8"	2-1/8" OD	16	1-3/8"	TP-210
2-1/2"	2-1/2" OD	16	1-3/8"	TP-260
3"	3" OD	16	1-3/8"	TP-310
3-1/2"	3-1/2" OD	16	1-3/8"	TP-360
4"	4" OD	16	1-3/8"	TP-410
5"	5" OD	14	1-5/8"	TP-510
6"	6" OD	14	1-5/8"	TP-610
8"	8" ID	14	1-3/4"	TP-810
10"	10" ID	12	2"	TP-1010
12"	12" ID	12	2"	TP-1210
14"	14" ID	12	2"	TP-1410

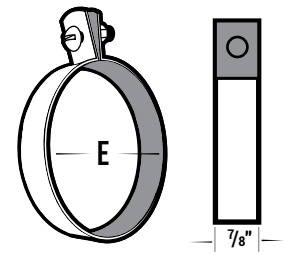

STANDARD TUBE HANGER

## TUBE HANGERS

- 2-1/8" to 14" ID
- Wall Thickness: 16 gauge
- Available only in Galvanized Steel

SIZE	E (ID)	GAUGE	PART NO.
2-1/8"	2-1/8"	16	TH-212
2-1/2"	2-1/2"	16	TH-250
3"	3"	16	TH-300
3-1/2"	3-1/2"	16	TH-350
4"	4"	16	TH-400
5"	5"	16	TH-500
6"	6"	16	TH-600
8"	8"	16	TH-800
10"	10"	16	TH-1000
12"	12"	16	TH-1200
14"	14"	16	TH-1400

## TUBE NIPPLES

- 2-1/8" to 14" OD
- Wall Thickness: 16, 14, 12 Gauge
- AVAILABLE IN 11 GAUGE

SIZE	A (OD)	GAUGE	C	PART NO.
2-1/8"	2-1/8"	16	2-1/2"	TN-211
2-1/2"	2-1/2"	16	2-1/2"	TN-261
3"	3"	16	2-1/2"	TN-311
3-1/2"	3-1/2"	16	2-1/2"	TN-361
4"	4"	16	2-1/2"	TN-411
5"	5"	14	3"	TN-511
6"	6"	14	3"	TN-611
8"	8"	14	4"	TN-811
10"	10"	12	5"	TN-1011
12"	12"	12	6"	TN-1211
14"	14"	12	7"	TN-1411

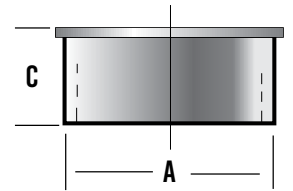

TUBE PLUG

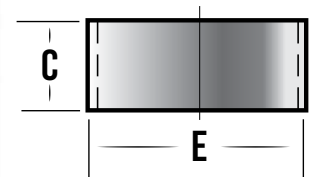

SLIP WELD RING

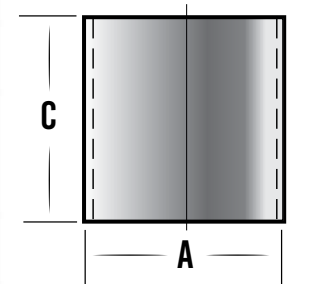

TUBE NIPPLE

### KEY

ID = Inside Diameter  
 OD = Outside Diameter  
 All reference dimensions are nominal.

**WHEN ORDERING,  
 PLEASE SPECIFY  
 TYPE OF MATERIAL**

- Carbon
- Stainless
- Aluminum
- Galvanized Steel

## INSTALLATION COMPONENTS

*Legends Equipment gives you everything you need to get your system up and running, all in one complete installation package. If you're searching for a particular installation component, we'll be glad to help you find whatever you're looking for. Our "one-stop-shopping" will help you lower your inventory costs and spend less time looking for parts. And, when it's time for installation, you'll have all the components you need on-the-spot.*

DESCRIPTION	SIZE	MATERIAL	PKGD.	PART NO.
<b>Anchor, Hilti®</b>	3/8" x 1-9/16" (Length)	Zinc	50 pc.	ANC-0380
<b>Bolt Anchor,</b> Includes Washer and Hex Nut	3/8" x 3-3/4" (Overall Length) 1-1/8" Thread Length	Zinc	100 pc.	ANC-0381
<i>Features: Comprehensive performance testing in concrete, lightweight concrete, and grout-filled block base materials. Can be installed in a bottomless hole. Anchor size is same as hole size for easy installation. Hilti® Kwik Bolt II Stud Anchor System.</i>				
<b>Hex Head Cap Screw</b>	3/8" x 1-1/4" (Length)	Zinc	50 pc.	HCS-0381
<i>"More Length When You Need It"</i>				
<b>Hex Nut</b>	3/8"	Zinc	50 pc.	HXN-0380
<b>Flat Washer</b>	3/8"	Zinc	50 pc.	FW-0380
<b>Split Lock Washer</b>	3/8"	Zinc	50 pc.	LKW-0380
<b>Threaded Rod</b>	3/8" x 6' (Length)	Zinc	each	ATR-100
<b>Eye Nut,</b> Maximum Allowable Load is 610 lbs.	3/8" Tapped Hole	Malleable Iron - Plain.	each	EN-0380
<i>"Works Great With our Tube Hangers"</i>				
<b>Coupler Nut</b>	3/8" x 1-3/4" (Length)	Zinc	each	CN-0380
<b>Beam Clamp</b> with Zinc Set Screw and Lock Nut.	3/8" Tapped Hole	Malleable Iron - Galv.	each	BC-037T
Maximum Allowable Load, in top or bottom position, is 550 lbs.				
<b>Beam Clamp</b> with Set Screw and Lock Nut.	3/8" Tapped Hole	Malleable Iron - Plain	each	BC-100
Maximum Allowable Load, in top position, is 500 lbs.; in bottom position, 250 lbs. <i>"The Cost-Effective Solution When You Don't Need Our Heavy-Duty Beam Clamp (BC-037T)"</i>				
<b>Channel Nut, without spring</b>	3/8"	Zinc	each	CHN-0380
<b>Saddlenut Assembly</b>		Zinc	50	SN-0380
<i>"Replaces Square Washer Plate and a Channel Nut Combination"</i>				
<b>Slotted Strut, 14 Gauge</b>	13/16"(D) x 1-5/8", 10' Length	Zinc	each	UN-100
<b>Slotted Strut, 14 Gauge</b>	1-5/8"(D) x 1-5/8", 10' Length	Zinc	each	UN-201
<i>"An Economical Alternative When You Don't Require Our Heavy-Duty Strut (UN-202)"</i>				
<b>Slotted Strut, 12 Gauge</b>	1-5/8"(D) x 1-5/8", 10' Length	Zinc	each	UN-202

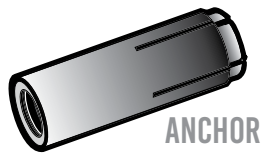

ANCHOR

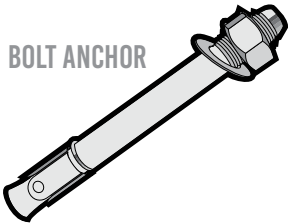

BOLT ANCHOR

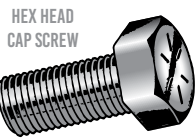

HEX HEAD  
CAP SCREW

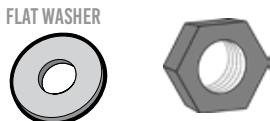

FLAT WASHER

SPLIT LOCK WASHER



THREADED ROD

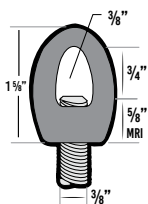

EYE NUT

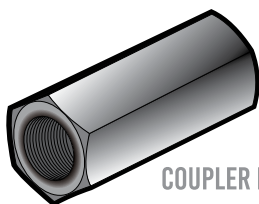

COUPLER NUT

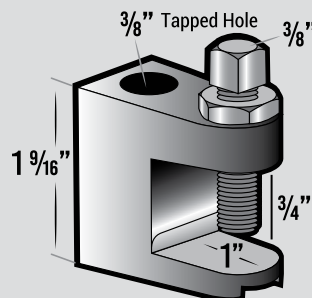

BEAM CLAMP

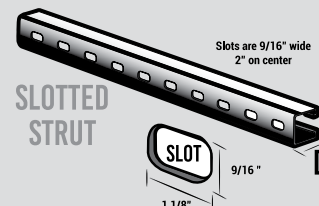

SLOTTED  
STRUT



## INSTALLATION COMPONENTS - CONT.

DESCRIPTION	SIZE	MATERIAL	PKGD.	PART NO.
<b>90° Strut Bracket</b>	2 x 2, 9/16" Holes	Zinc	each	BRKT-0900
<b>90° Strut Bracket</b>	2 x 1, 9/16" Holes	Zinc	each	BRKT-0901
<b>45° Strut Bracket</b>	9/16" Holes	Zinc	each	BRKT-0450
<b>Square Washer Plate</b>	7/16" Hole for 3/8" Bolt Size	Zinc	100 pc.	SQW-0380
<b>Tube Hanger, includes Bolt and Nut</b>	For 1-1/2" OD Tube	Zinc	each	TH-150
<b>Tube Hanger, includes Bolt and Nut</b>	For 2" OD Tube	Zinc	each	TH-200
<b>Tube Hanger, includes Bolt and Nut</b>	For 2-1/8" and 2-1/4" OD Tube	Zinc	each	TH-212
<b>Tube Hanger, includes Bolt and Nut</b>	For 2-1/2" OD Tube	Zinc	each	TH-250
<b>Tube Hanger, includes Bolt and Nut</b>	For 3" OD Tube	Zinc	each	TH-300
<b>Tube Hanger, includes Bolt and Nut</b>	For 3-1/2" OD Tube	Zinc	each	TH-350
<b>Tube Hanger, includes Bolt and Nut</b>	For 4" OD Tube	Zinc	each	TH-400
<b>Tube Hanger, includes Bolt and Nut</b>	For 4-1/2" OD Tube	Zinc	each	TH-450
<b>Tube Hanger, includes Bolt and Nut</b>	For 5" OD Tube	Zinc	each	TH-500
<b>Tube Hanger, includes Bolt and Nut</b>	For 6" OD Tube	Zinc	each	TH-600
<b>Tube Hanger, includes Bolt and Nut</b>	For 8" OD Tube	Zinc	each	TH-800
<b>Tube Hanger, includes Bolt and Nut</b>	For 10" OD Tube	Zinc	each	TH-1000
<b>Tube Hanger, includes Bolt and Nut</b>	For 12" OD Tube	Zinc	each	TH-1200
<b>Tube Hanger, includes Bolt and Nut</b>	For 14" OD Tube	Zinc	each	TH-1400
<b>Pipe Clamp, includes Slotted Hex Head Screw and Nut, Design Load 800 lbs.</b>	For 1-1/2" Pipe Size	Zinc	4 pc.	PCL-150
<b>Pipe Clamp, includes Slotted Hex Head Screw and Nut, Design Load 800 lbs.</b>	For 2" Pipe Size	Zinc	4 pc.	PCL-200
<b>Pipe Clamp, includes Slotted Hex Head Screw and Nut, Design Load 800 lbs.</b>	For 2-1/2" Pipe Size	Zinc	4 pc.	PCL-250
<b>Pipe Clamp, includes Slotted Hex Head Screw and Nut, Design Load 800 lbs.</b>	For 3" Pipe Size	Zinc	4 pc.	TCL-350*
<b>Pipe Clamp, includes Slotted Hex Head Screw and Nut, Design Load 1000 lbs.</b>	For 3-1/2" Pipe Size	Zinc	4 pc.	TCL-400*
<b>Pipe Clamp, includes Slotted Hex Head Screw and Nut, Design Load 1000 lbs.</b>	For 4" Pipe Size	Zinc	4 pc.	TCL-450*
<b>Pipe Clamp, includes Slotted Hex Head Screw and Nut, Design Load 1000 lbs.</b>	For 5" Pipe Size	Zinc	4 pc.	PCL-500
<b>Pipe Clamp, includes Slotted Hex Head Screw and Nut, Design Load 1000 lbs.</b>	For 6" Pipe Size	Zinc	4 pc.	PCL-600
<b>Pipe Clamp, includes Slotted Hex Head Screw and Nut, Design Load 1000 lbs.</b>	For 8" Pipe Size	Zinc	4 pc.	PCL-800

\* Tube Clamp also fits this pipe size.

### KEY

Zinc = Galvanized Carbon Steel  
 OD = Outside Diameter  
 All reference dimensions are nominal.



CHANNEL NUT

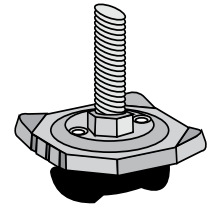

SADDLE NUT ASSEMBLY

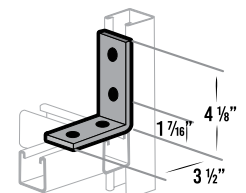

90° STRUT BRACKET  
2 HOLES X 2 HOLES

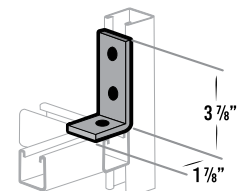

90° STRUT BRACKET  
2 HOLES X 1 HOLES

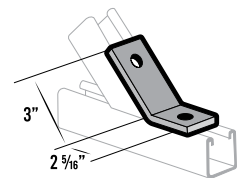

45° STRUT BRACKET  
1 HOLES X 1 HOLES

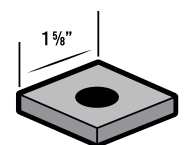

SQUARE WASHER PLATE

# ACCESSORIES

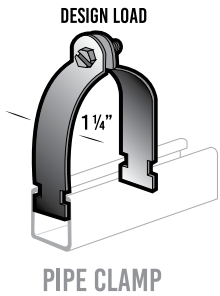

## INSTALLATION COMPONENTS - CONT.

DESCRIPTION	SIZE	MATERIAL	PKGD.	PART NO.
<b>Tube Clamp</b> , includes Slotted Hex Head Screw and Nut, Design Load 600 lbs.	For 1-1/2" OD Tube	Zinc	4 pc.	TCL-150
<b>Tube Clamp</b> , includes Slotted Hex Head Screw and Nut, Design Load 800 lbs.	For 2" OD Tube	Zinc	4 pc.	TCL-200
<b>Tube Clamp</b> , includes Slotted Hex Head Screw and Nut, Design Load 800 lbs.	For 2-1/8" OD Tube	Zinc	4 pc.	TCL-212
<b>Tube Clamp</b> , includes Slotted Hex Head Screw and Nut, Design Load 800 lbs.	For 2-1/2" OD Tube	Zinc	4 pc.	TCL-250
<b>Tube Clamp</b> , includes Slotted Hex Head Screw and Nut, Design Load 800 lbs.	For 3" OD Tube	Zinc	4 pc.	TCL-300
<b>Tube Clamp</b> , includes Slotted Hex Head Screw and Nut, Design Load 800 lbs.	For 3-1/2" OD Tube	Zinc	4 pc.	TCL-350
<b>Tube Clamp</b> , includes Slotted Hex Head Screw and Nut, Design Load 1000 lbs.	For 4" OD Tube	Zinc	4 pc.	TCL-400
<b>Tube Clamp</b> , includes Slotted Hex Head Screw and Nut, Design Load 1000 lbs.	For 4-1/2" OD Tube	Zinc	4 pc.	TCL-450
<b>Tube Clamp</b> , includes Slotted Hex Head Screw and Nut, Design Load 1000 lbs.	For 5" OD Tube	Zinc	4 pc.	TCL-500
<b>Tube Clamp</b> , includes Slotted Hex Head Screw and Nut, Design Load 1000 lbs.	For 6" OD Tube	Zinc	4 pc.	TCL-600
<b>Tube Clamp</b> , includes Slotted Hex Head Screw and Nut, Design Load 1000 lbs.	For 8" OD Tube	Zinc	2 pc.	TCL-800**
** 2 piece package				
<b>Firestop Sealant</b>	10.5-oz. Tube	-	each	FST-100
<b>Cleaner</b>	Quart	-	each	2868
<b>Metal Sealant</b>	Quart Can	-	each	2084-QT

An aluminum-colored, medium viscosity, synthetic rubber sealant with excellent adhesion to many metal, glass, wood and other surfaces.

Features: Adheres to metal, wood and glass. Seals metal to glass in windows and doors. Resists weather, water, oil and gasoline. Solids wt. approx. 46%, Flash Point (closed cup) 0° F, heavy liquid consistency, aluminum color (dry), brush or flow application. Drying time is 24 hours (1/8" dia. bead), service temp. range of -30° to 200° F. 3M Scotch-Seal™ 2084 Metal Sealant repackaged.

### NOTE:

Tube Clamps are now available in 50 packs! To order, simply add -50 to the end of the Part Number!

### KEY

Zinc = Galvanized Carbon Steel  
 OD = Outside Diameter  
 All reference dimensions are nominal.

# Legends Equipment LLC



**LegendsEquipment.com**

**(513) 337-9745**